



Thank you for choosing PROJOY products.
Please read carefully before installation.

PROJOY
electric

– *Switch To Safety!* –

PROJOY PEFS

FIREFIGHTER SAFETY SWITCH

Instructions for Installation and Operation

General Notice

1. Changes or modifications not explained/approved in this manual voids your authority to operate this equipment.
2. PROJOY shall not be held responsible for any damage caused due to incorrect installation of the product and/or the misunderstanding of this manual.
3. PROJOY reserves the right to make any modification to this manual or the information contained herein at any time without notice.
4. No design data such as sample pictures provided in this manual may be modified or duplicated except for the purpose of personal use.
5. To ensure the recycling of all possible materials and proper disposal treatment of components, please return the product to PROJOY at end-of-life.
6. Check the system regularly (once per 3 months) on faults.

Important Safety Precautions

Components in the installations are exposed to high voltages and currents. Follow these instructions carefully in order to reduce the risk of fire or electric shock.

The following regulations and standards are considered applicable and mandatory to read prior to the installation of electrical equipment:

1. International Standards: IEC 60364-7-712 Electrical installations of buildings-Requirements for special installations or locations-Solar Photovoltaic (PV) power supply systems.
2. Local building regulations.
3. Guidelines for lightning and overvoltage protection.

Note!

1. It is essential to uphold the limits for voltage and current in all possible operating conditions. Also keep in mind the literature on correct dimensioning and sizing of cabling and components.

2. The installation of these devices may only be performed by certified technical personnel.
3. The wiring schematics of the Firefighter Safety Switch can be found at the end of this manual.
4. All the installation works should be tested in accordance with relevant local legislation at the time of installation.

Intended Use of the Firefighter Safety Switch

The Firefighter Safety Switch (PEFS) has been especially developed as a safety device for direct current (DC) photovoltaic installations. The DC disconnect switch is used to disconnect the connected strings of the installation in case of an emergency situation. Such an emergency situation could be in case of fire.

Location of the Firefighter Safety Switch

The PEFS needs to be placed as close to the solar panels as possible. Due to its enclosure, the switch is protected against external influences like dust and moisture. The whole set-up is conforms to IP66 which makes it suitable for outdoor usage when needed.

Normal operation:

The PEFS will automatically switch to the off position, breaking the DC connection between the solar panels and the inverter, after the AC power to the PEFS is interrupted for longer than five seconds. The PEFS will automatically switch to the on position, restoring the DC connection between the solar panels and the inverter, once the AC power to the PEFS is restored longer than five seconds.

Special Operation

If the temperature inside the PEFS enclosure exceeds the 70 °C, the PEFS will automatically switch to OFF to protect the internal components and create a safe situation. When the installation is checked and the PEFS is not affected, the PEFS can be switched ON again by removal and re-applying the AC voltage to the PEFS. The PEFS will also automatically switch to OFF if there is an internal failure. If this occurs please try to reset the PEFS by removal and re-applying the AC voltage to the PEFS.

WIRING OPTIONS

1. Kit with cable glands



2. Kit with pre-wired MC4.

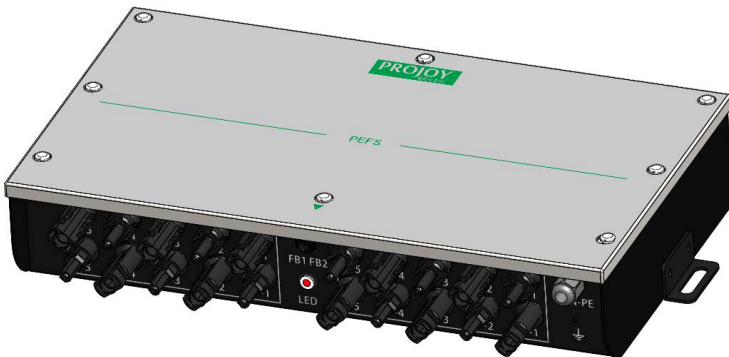

INSTALLATION

1 Installation Requirements

Open the box, take out PEFS, read this manual, and prepare cross/straight screwdriver.

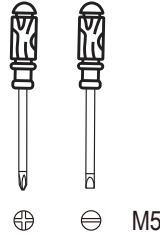
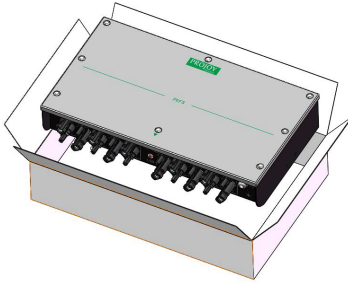

2 Remove the lid from the enclosure.

Remove the 8xM5 screws with cross screwdriver, open the lid.

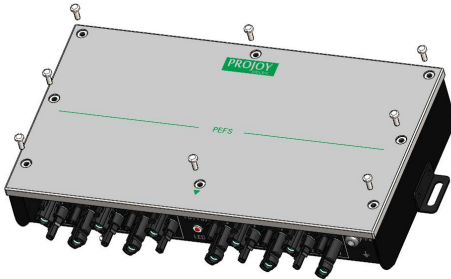

3 Mount the switch enclosure on the wall.

Note: The screw is M8 self-tapping screw.

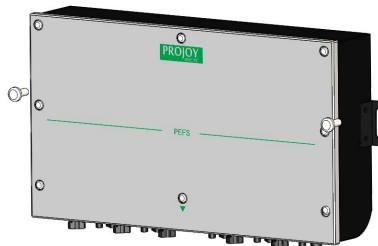

● Wire the power AC connection to the terminals.

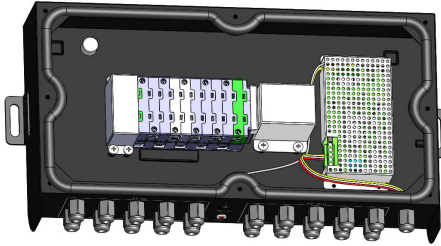

(AC Cable: MAX. 0.75 mm \boxtimes)

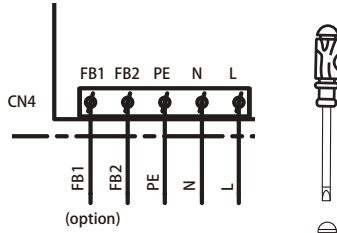

AC Current: 30mA

Operating voltage 100Vac - 270Vac

Note: FB1, FB2 are used to remotely display the on and off states of the switch. When the switch is closed, FB1 is connected to FB2; when the switch is open, FB1 is disconnected from FB2.

The enclosure needs to add a M12 cable gland if the remotedisplay function is needed.

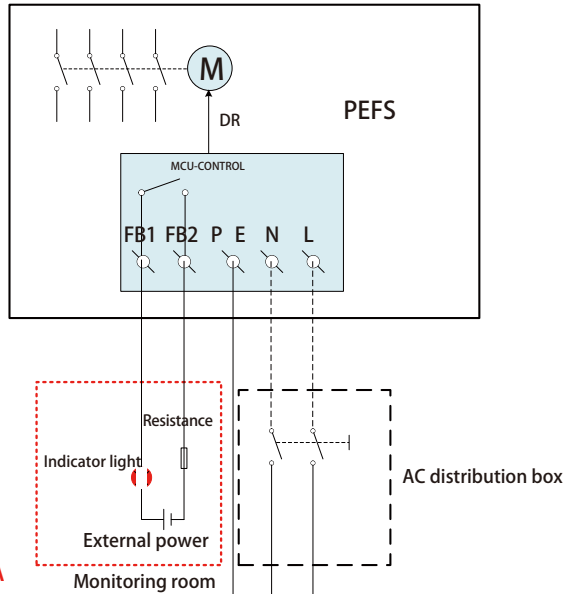

Note:
 External power: +5~48V, > 150mA
 Resistance: metal shell, > 10W

Resistor is selected according to supply voltage, to ensure circuit current less than the rated current of the Indicator light and < 320mA

5 Wire the string cables to the interface.



Note: Please follow the marks (+, -) for PV wiring.

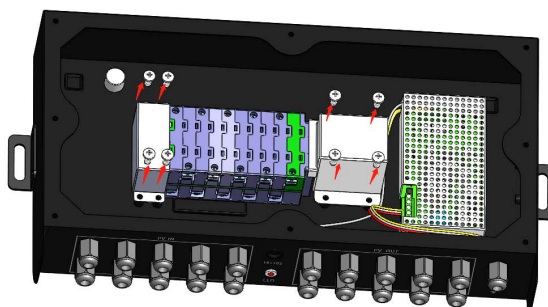

Remove the screw

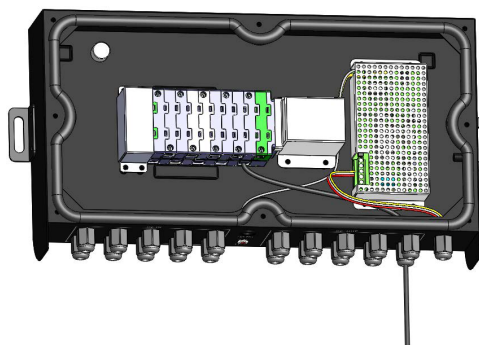

MAX. 1.7Nm

Wire the string cables (DC) to the switch

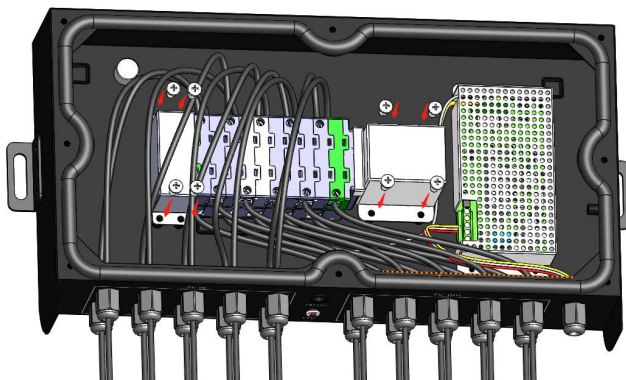

Then Lock screws.

- 6 Close the switch enclosure with cross screwdriver.

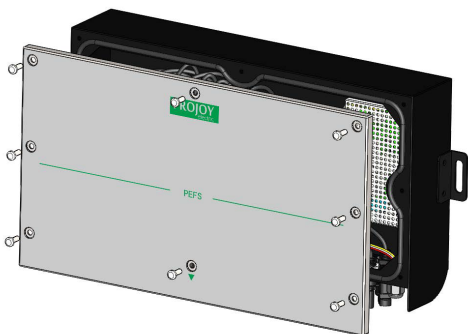

M5(8x) - Max. 1.7

7 Test

Step 1. Activate AC power circuit. PEFS switches on.



Approx. 35 sec.

Step 2. Wait one minute. UPS is charging.



Approx. 1 min.

Step 3. Deactivate AC power circuit. PEFS will switch off in about 7 seconds.
Red LED light off.



Approx. 7 sec.

Step 4. Activate AC power circuit. PEFS switches on in 8 seconds.
Red LED light on.



Approx. 8 sec.

Step 5. Test is completed.