



PURE SINE WAVE INVERTER

USER MANUAL



Models:
IP1500-Plus
IP2000-Plus
IP3000-Plus

Contents

| | |
|---|----|
| Important Safety Instructions | 1 |
| 1. Overview | 6 |
| 2. Characteristics | 8 |
| 3. Designations of models..... | 10 |
| 4. Schematic diagram for connections..... | 11 |
| 5. LCDdisplay unit..... | 12 |
| 5.1 LCD | 12 |
| 5.2 LED indicator and buzzer | 12 |
| 5.3 Button..... | 13 |
| 5.4 Display interface | 13 |
| 5.5 Setting interface | 13 |
| 5.6 Fault code | 14 |
| 6. Installation instructions..... | 15 |
| 6.1 General installation notes | 15 |
| 6.2 Wire size & breaker..... | 16 |
| 6.3 Mounting | 16 |
| 6.4 Rotate the LCD | 21 |
| 7. Protection | 22 |
| 8. Troubleshooting..... | 25 |
| 9. Maintenance..... | 26 |
| 10. Technical Specifications | 27 |
| Annex I Disclaimer..... | 31 |

Important Safety Instructions

Please reserve this manual for future review.

This manual contains all the instructions about safety, installation, and operation for the IPower Plus series pure sine wave inverter (Shown as “inverter” in the rest of the manual).

1. Symbols Definition

To ensure safety and use the product efficiently, when you see the below symbols in the manual, please pay attention to them and read the related content carefully.

TIP:

Indicates any practical advice for reference.



IMPORTANT:

Indicates a critical tip during the operation, if ignored, may cause the device to run in error.



CAUTION:

Indicates potential hazards, if not avoided, may cause the device damaged.



WARNING:

Indicates the danger of electric shock, if not avoided, would cause casualties.



WARNING HOT SURFACE:

Indicates the risk of high temperature, if not avoided, would cause scalds.



Read the manual carefully before any operation.



WARNING: The installation of the system must be done by professional technicians.

2. Requirements for technicians

- Professionally trained;

- Familiar with related safety specification of the electrical system;
- Read through the whole manual and be familiar with operating procedures and safety precautions.

3. Technicians operating permission

- Install the inverter to the specified location;
- Pretesting the inverter;
- Operation and maintenance of the inverter.

4. Safety cautions before installation



IMPORTANT: After receiving the inverter, please check the product condition first, if there is any damage occurred during shipping, please contact the transportation company or us in time.



CAUTION: Follow the instructions in the manual before placing or moving the inverter.



CAUTION: Make sure there isn't any electrical arcing danger around the operation area before installation.



CAUTION: Connect the inverter to the battery is highly recommended; the minimum capacity (Ah) of the battery should be 5 times of the inverter rated output power (P) divide by the battery voltage (V), which means $Ah=5 \times (P/V)$.



WARNING: Keep the inverter away from children.



WARNING: This off-grid inverter may be damaged if connected to the utility or electrical source.



WARNING: Only a single inverter is allowed to operate at a time. Do NOT connect multiple inverters in series or parallel. It may cause the inverter damaged.

5. Safety cautions for installation



WARNING: Make sure the inverter is clean and no electrical connection before installation.



WARNING: Make sure there is enough heat dissipation space for the inverter installation, and do not install the inverter in humid, greasy, flammable, explosive, dust accumulative or other severe environments.

6. Safety cautions for electrical connection



CAUTION: To avoid the danger of heat accumulation caused by the loose connection, please ensure all the cable connections are tight.



CAUTION: Please connect the inverter case to the ground and ensure the sectional area of the connection cable is not less than 4mm^2 .



CAUTION: Follow the parameter setting requirements to set the DC input voltage, higher or lower may cause the inverter down or even broken.



CAUTION: The cable between battery and inverter should be less than 3meters, otherwise, please reduce the current density.



CAUTION: A fuse or breaker is recommended between battery and inverter, also the rated current of the fuse or breaker should be two times of the inverter rated input current.



CAUTION: Keep the inverter away from the flooded lead-acid battery because the sparkle of the terminals may ignite the hydrogen released by the battery.



WARNING: Only the load is allowed to connect to the AC output terminal, do NOT connect it to power supply or utility, which may cause the inverter damaged, also please shut off the inverter before wiring.



WARNING: Do NOT directly connect the battery charger or similar devices to the input terminal of the inverter.

7. Safety cautions for inverter operation



WARNING HOT SURFACE: Do NOT touch the inverter when it's operating, the inverter case of the inverter will generate a high value of heat, also keep distance to the material or equipment affected by high temperature.



CAUTION: Do NOT open the inverter external case or try any operation when the inverter is ON.



WARNING: The AC output with high voltage during the inverter operation, do NOT touch any connection point, it may cause danger.

8. The dangerous operations which would cause electric arc, fire or explosion

- Touch the wire end, which hasn't been insulation treated, may cause electric shock.
- Touch the wiring copper row, terminals or internal devices, which may cause electric shock.
- The power cable connection is loose.
- Screw or other components inadvertently falls into the inverter.
- Incorrect operation by untrained non-professional people.



WARNING: When a fault occurs, please ask trained technicians to solve the issue. Any incorrect operation would cause a serious accident.

9. Safety cautions for shutting off the inverter

- The internal conductive devices are allowed to touch after the inverter has been shut off completely for ten minutes.
- The inverter is allowed to restart after removing the fault which affects the safety performance of the inverter.
- No maintenance parts are included in the inverter, please contact our customer service department for required maintenance service.



WARNING: Do NOT touch or open the external case before the device is shut off completely for ten minutes.

10. Safety cautions for inverter maintenance

- Testing equipment recommend to check the inverter without voltage or current;
- During installation and maintenance, please post temporary warning signs or put up roadblocks to prevent unrelated people from entering the area.
- Improper maintenance operations to the inverter may cause personal injury or equipment damage.
- To prevent electrostatic damage, please wear an antistatic wrist strap or avoid unnecessary contact with the circuit board.

1. Overview

IPower Plus is a new series of pure sine wave inverter which compatible with the lithium battery system. This new inverter with the input surge current suppression technology, which effectively prevents the damage of surge current to lithium battery cell and BMS (Battery Management System). Also, the smart voltage and current double closed-loop control algorithm bring the inverter a faster response and better resistance to load impact. The internal of the inverter uses high quality and high power density of the components to provide the stable, reliable, and sufficient power output for long time use. The optional communication solution allows people to monitor the operational status in real-time or change the parameters at any place.

The equipment fits multiple areas where need DC to AC, such as solar AC power system, vehicle system, RV power supply, security monitoring system, emergency lighting system, field power system, household power system, etc. The inverter with the EMC (Electro Magnetic Compatibility) characteristic is also available for higher power quality required place.

Feature:

- The input and output adopt completely isolated design
- Smart voltage and current double closed-loop control bring a faster response and better reliability.
- EMC characteristic which widely applied to higher quality requirement power system.
- Adoption of advanced SPWM technology and pure sine wave output
- Input surge current suppression technology to support the lithium battery system.
- Resistance to load impact supports impact loads (Air conditioner, Washing machine, Refrigerator, etc.)
- High power density and High-quality components to ensure reliability.
- Output power factor up to 1
- Low loss of no-load and standby.
- Low THD (Total Harmonic Distortion)

- High conversion efficiency.
- Extensive protection: input reverse polarity, input overvoltage, input low voltage, output overload, and short circuit, overheating.
- Air cooling control by dual condition (Temperature and Load)
- 180 degree rotatable LCD design to simplify the system wiring
- One-click control of operational status
- Friendly LCD design to simply monitor and parameter configure
- Supports phone Apps and PC software remote control
- Output voltage 220/230VAC and frequency 50/60Hz optional^①
- USB[®] ports to power DC fans, and other electronic equipments or charge phones.
- RS485 communication port supports multiple optional accessories.
- External switch contact design to allow remote control
- IEC62109, EN61000, RoHS approved

①Parameters can be monitored via inverter LCD, remote LCD, phone Apps, and PC software.

②USB function unavailable for 48V input inverters.

2. Characteristics

IP1500-12-Plus/IP2000-**-Plus

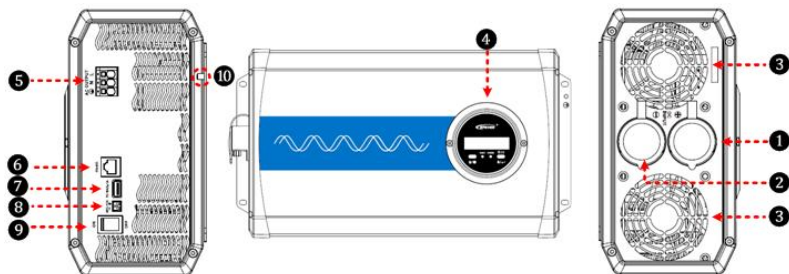

IP3000-12-Plus

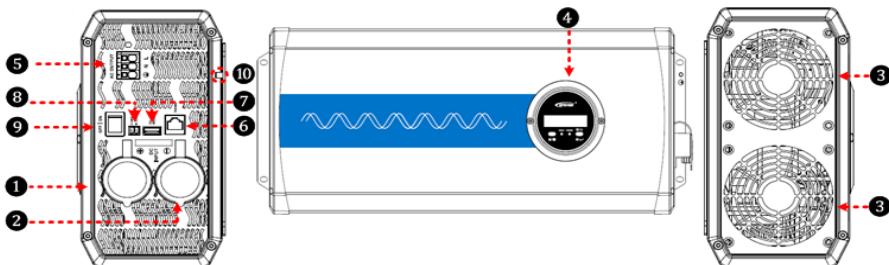

| | | | |
|---|------------------------------|---|--|
| ① | DC input terminal positive | ⑥ | RS485 communication port |
| ② | DC input terminal negative | ⑦ | USB output port 5VDC/Max.1A [®] |
| ③ | Ventilation fan ^① | ⑧ | External switch connection point |
| ④ | LCD | ⑨ | Inverter switch |
| ⑤ | AC output terminal | ⑩ | Grounding terminal |

① Ventilation fan

1) The cooling fan will automatically turn on if the inverter could reach any condition as below.

- Heat sink temperature is higher than 50°C.
- The Internal temperature is higher than 50°C.
- The output power is higher than 50% of the rated power.

2) The cooling fan will automatically turn off when the inverter reaches all the conditions as below.

- Heat sink temperature is lower than 40°C.
- The Internal temperature is lower than 40°C.
- The output power is lower than 40% of the rated power.

②The products of the 48V input system do not support the USB output port.

3. Designations of models

IP 3000 - 4 2 -Plus(I)

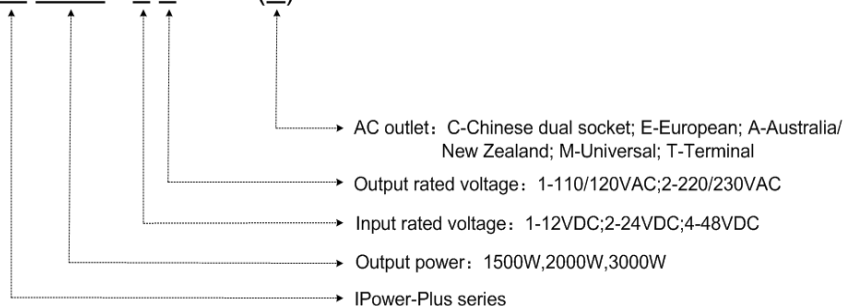

4. Schematic diagram for connections

IP1500-12-Plus/IP2000-**-Plus

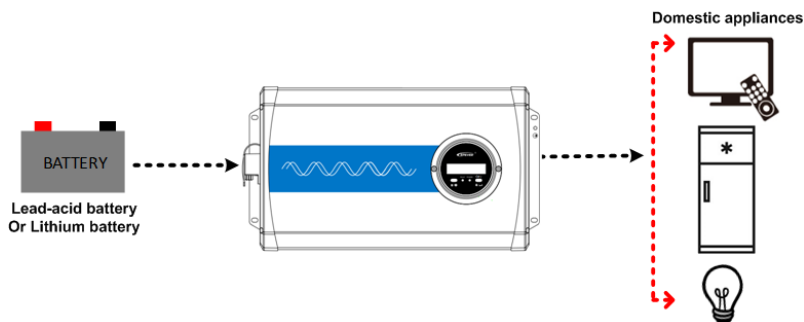

IP3000-12-Plus

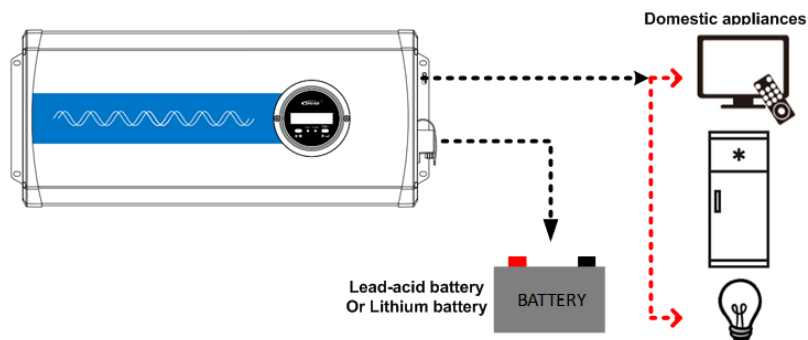

CAUTION: Suggest that the DC input terminal of the inverter directly connects to the battery. DO NOT connect to the battery terminal of the charge source. Otherwise, the charging voltage spikes of the charge source may lead to over-voltage protection of the inverter.

5. LCDdisplay unit

5.1LCD

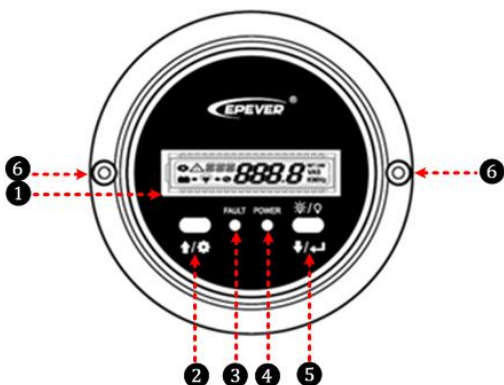

| | | | |
|---|----------------------|---|---|
| ① | LCD | ④ | Working status indicator(Blue) |
| ② | UP/Setting button | ⑤ | DOWN/Enter button Output ON/OFF button |
| ③ | Fault indicator(red) | ⑥ | Screw of the LCD |

5.2 LED indicator and buzzer

| Working status indicator | Fault indicator | Buzzer | Status |
|-----------------------------|------------------------|------------------|--|
| Blue on solid | Red off | Buzzer no sounds | Output is normal |
| Blue slowly flashing(1/4Hz) | Red off | Buzzer sounds | Input under voltage |
| Blue fast flashing(1Hz) | Red off | Buzzer sounds | Input overvoltage |
| Blue off | Red on solid | Buzzer sounds | Internal or heat sink over temperature |
| Blue off | Red fast flashing(1Hz) | Buzzer sounds | Load short circuit |
| Blue on solid | Red slowly | Buzzer | Load overload |

| | | | |
|----------|-----------------|---------------|--------------------------------|
| | flashing(1/4Hz) | sounds | |
| Blue off | Red off | Buzzer sounds | The output voltage is abnormal |

5.3 Button

| | | |
|--|---------------------------------|--|
| | Press the button | Up |
| | Press the button and hold on 2s | Enter the setting interface at the real-time interface Enter the parameter's setting interface at the setting interface |
| | Press the button | Down |
| | Press the button and hold on 2s | The output is ON/OFF (Default ON) Enter the setting interface |
| | Press the button | Exit the parameter's setting interface at the setting interface |
| | Press the button and hold on 2s | Clear the faults at the real-time interface (Load short circuit or overload) |



CAUTION: The long sound (300ms) of the buzzer is for setting parameters; the short sound (100ms) of the buzzer is for key operations.

5.4 Display interface

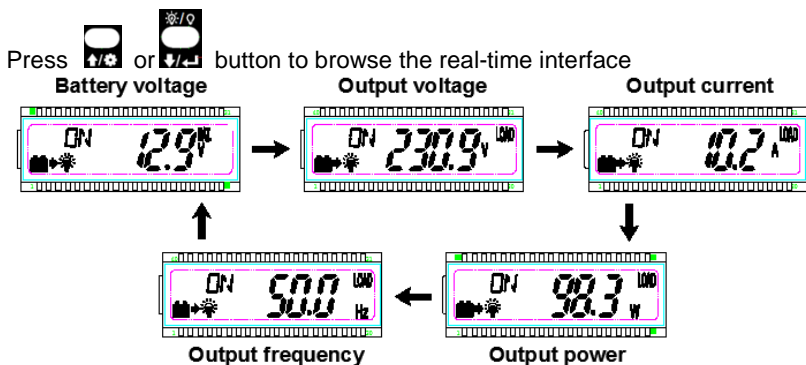

5.5 Setting interface

Operation

Step 1: Long press  to into the setting interface;

Step2: Press  or  to select the setting item;

Step3: Long press  and the digit is flashing to set the parameter;

Step4: Long press  to enter the parameter;

Step5: Press  and  to exit the setting interface.

| Display | Parameter | Default | Setting range |
|---------|--|---------|--------------------------------|
| ⚙️ VPT | Output voltage class ^① | 220Vac | 220Vac/230Vac |
| | | 110Vac | 110Vac/120Vac |
| ⚙️ FRE | Output frequency class ^① | 50Hz | 50Hz/60Hz |
| ⚙️ BLT | LCD backlight time | 30s | 30s/60s/100s(On Solid) |
| ⚙️ LVD | Low voltage disconnect voltage ^② | 10.8V | 10.5V~11.3V; step size 0.1V |
| ⚙️ LVR | Low voltage reconnect voltage ^② | 12.5V | 12.0V~13.0V; step size 0.1V |
| ⚙️ OVR | Over voltage reconnect voltage ^② | 14.5V | 14.0V~15.0V; step size 0.1V |
| ⚙️ OVD | Over voltage disconnect voltage ^② | 16V | 15.5V~16.2V; step size 0.1V |

①The inverter must be restarted after change the parameters.

②4-6 parameters are in the 12V system at 25 °C; please double the values in the24V system and quadruple the values in the48V system.

③The user-defined range of 24V system is 31~32.2V, and the user-defined range of 24V system is for the 7 parameter.

5.6Fault code

| Fault code | Fault | Buzzer |
|------------|---|-------------------|
| ΔTPT | Internal over temperature Heat sink over temperature | Sounds five times |
| ΔIOV | Input overvoltage | |
| ΔILV | Input low voltage | |
| ΔOSC | Output short circuit | |
| ΔOOL | Output overload | |
| ΔOVA | Output voltage is abnormal | |

6. Installation instructions

6.1 General installation notes

- Please read the manual carefully to get familiar with the installation steps before installation.
- Be very careful when installing the batteries, especially flooded lead-acid batteries. Please wear eye protection, and have fresh water available to rinse if any contact with battery acid.
- Keep the battery away from any metal objects, which may cause a short circuit of the battery.
- Loose connections and corroded wires may result in high heat that can melt wire insulation, burn surrounding materials, or even cause a fire. Ensure tight connections and use cable clamps to secure cables and prevent them from swaying in motion.
- Please follow the parameter list to connect the DC input, even though the inverter has a high range of DC input voltages. Too high or too low may cause the inverter to stop working, even damage the inverter (Surge voltage less than 20V for 12V system, 40V for 24V system, 80V for 48V system)
- Select the system connection cables according to the current density no higher than $3.5\text{A}/\text{mm}^2$. (In accordance with the National Electrical Code Article 690, NFPA70).
- For outdoor installation, keep out of the direct sunshine and rain infiltration.
- High voltage still exists inside the inverter after turning off the switch, do not open or touch the internal devices, wait ten minutes before conducting related operations.
- Please do not install the inverter in humid, greasy, flammable, explosive, dust accumulative, or other severe environments.
- AC output is a high voltage, and please do not touch the wiring connection.
- When the fan is working, and please do not touch it to avoid injury.

6.2 Wire size & breaker

Wiring and installation should comply with national and local electrical requirements.

➤ Wire, terminals and breaker selection for battery

| Models | Battery wire size | Ring Terminal | Breaker |
|-------------------|---------------------------|---------------|-----------------------------|
| IP1500-12-Plus(T) | 35mm ² /1AWG | RNB38-6 | DC—100A (2P in parallel) |
| IP2000-12-Plus(T) | 50mm ² /1/0AWG | RNB60-10 | DC—125A (2P in parallel) |
| IP2000-22-Plus(T) | 25mm ² /3AWG | RNB22-6L | DC/2P—125A |
| IP2000-42-Plus(T) | 16mm ² /6AWG | RNB22-6L | DC/2P—63A |
| IP3000-12-Plus(T) | 70mm ² /3/0AWG | RNB60-10 | DC—125A (3P in parallel) |

➤ Wire and breaker selection for AC output

| Models | Wire size | Breaker |
|-------------------|---------------------------|-----------|
| IP1500-12-Plus(T) | 1.5mm ² /15AWG | AC/2P—10A |
| IP2000-12-Plus(T) | 2.5mm ² /13AWG | AC/2P—16A |
| IP2000-22-Plus(T) | 2.5mm ² /13AWG | AC/2P—16A |
| IP2000-42-Plus(T) | 2.5mm ² /13AWG | AC/2P—16A |
| IP3000-12-Plus(T) | 4mm ² /11AWG | AC/2P—25A |



IMPORTANT: The wire size and terminal are for reference only, use thicker wires to lower the voltage drop, and improve the system performance when the distance between inverter and batter is far.



IMPORTANT: The above wire size and circuit breaker size are for recommendation only, please choose suitable wire and circuit breaker according to the practical situation.

6.3 Mounting

Installation steps:

Step1: Professional personnel read this manual carefully.

Step2: Determination of installation location and heat-dissipation space.



IMPORTANT: The inverter shall be installed in a place with sufficient airflow through the dissipation pad of the inverter and a minimum clearance of 150mm from the upper and lower edges of the inverter to ensure natural thermal convection.



CAUTION: The inverter shall be cooling through case if installed in a closed box.

IP1500-12-Plus/IP2000-**-Plus

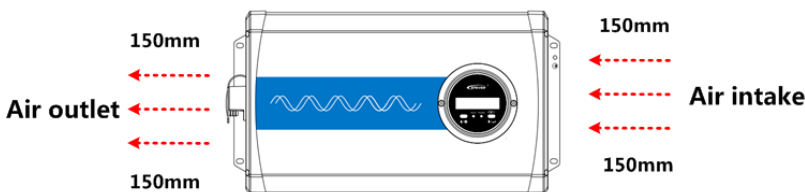

IP3000-12-Plus

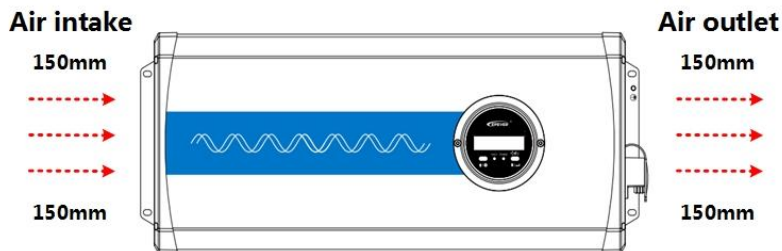

Step3: Wiring



WARNING: The AC equipment shall be determined by the continuous output power of the inverter, but the surge power must be lower than the instantaneous surge power of the inverter.



CAUTION: The switch of the inverter is OFF before wiring.



CAUTION: DO NOT close the circuit breaker or fuse and make sure that the leads of “+” and “-” poles are correctly connected while wiring the inverter.



CAUTION: A fuse which current is 2 to 2.5 times the rated current of the inverter, it must be installed on the battery side with a distance from the battery not greater than 150mm.

Wiring order:

1 Ground

IP1500-12/IP2000--Plus**

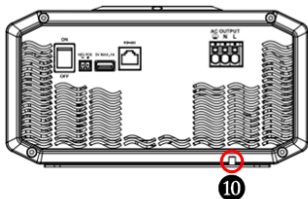

IP3000-12-Plus

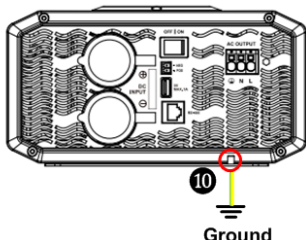

2 Battery

IP1500-12/IP2000--Plus**

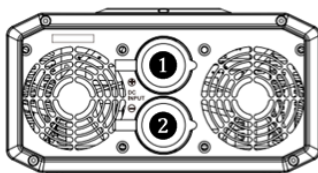

IP3000-12-Plus

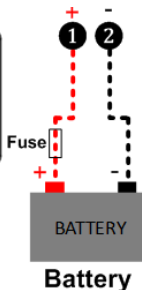
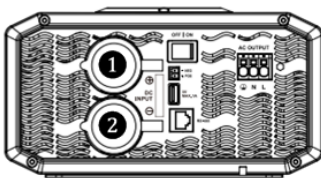

3 AC loads

1) AC output terminal definition

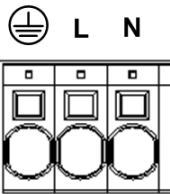
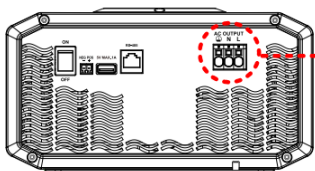

- ✦ Use multi-cores wire with no large than 4mm^2 is recommended
- ✦ Tin soldering to connection point when using multi-cores wires and directly insert into the related hole.
- ✦ Cut off the power and use a sharp tool to insert it into the small hole (on the top of the wire) before removing the wire.

2)Connect AC load

IP1500-12/IP2000--Plus**

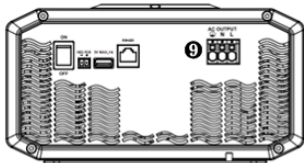

IP3000-12-Plus

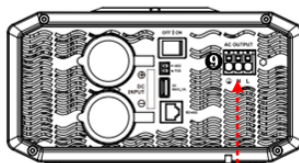

4 Accessories

1) **RS485 communication port**

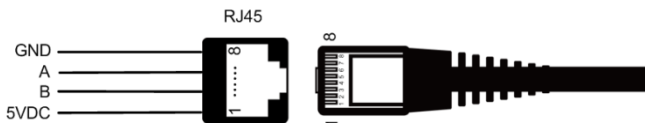

RJ45 pins definition:

| Pins | Definition | Pins | Definition |
|------|------------|------|------------|
| 1 | 5VDC | 5 | RS-485-A |
| 2 | 5VDC | 6 | RS-485-A |
| 3 | RS-485-B | 7 | GND |
| 4 | RS-485-B | 8 | GND |

2) Connect accessories

IP1500-12/IP2000-**-Plus



IP3000-12-Plus

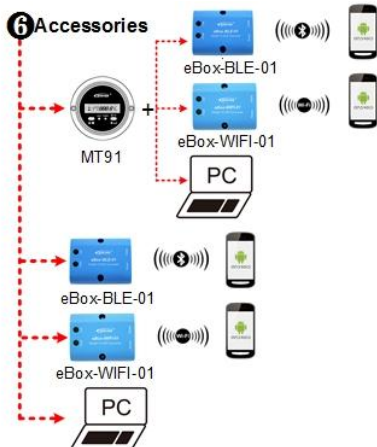
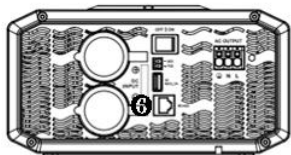

5 USB port

IP1500-12/IP2000-**-Plus

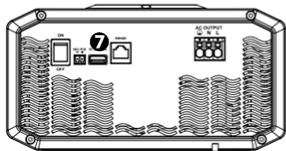

IP3000-12-Plus

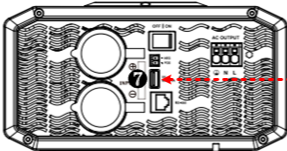

USB charge cable



Step4: Power on the inverter

- (1) Switch on the input breaker or the fuse between inverter and battery.
- (2) Turn on the power switch to start the inverter, blue indicator on solid, and the AC output is normal.
- (3) Turn on the load one by one, and check the operation status of both inverter and load.



CAUTION: If there are different types of loads, we suggests that

turn on the loads with higher startup current first, such as television, then at last the loads work stably, turn on the loads with lower startup current, such as an incandescent lamp.

- (4) If the fault indicator is red and the buzzer alarms when turn on the inverter, please switch off the loads and inverter immediately. Refer to **chapter 7 Troubleshooting**. After troubleshooting, please follow the above steps and operate again.

6.4 Rotate the LCD

- (1) Remove the screws with a screwdriver, then rotate the LCD 180°

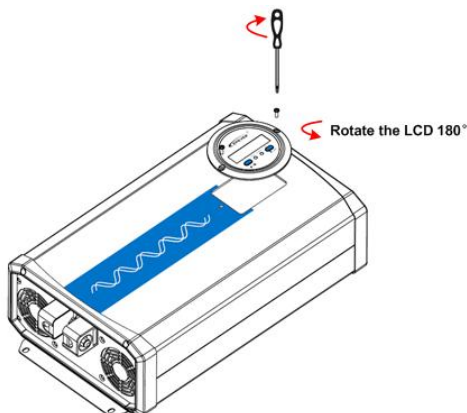

- (2) Set the screws of the LCD with a screwdriver.

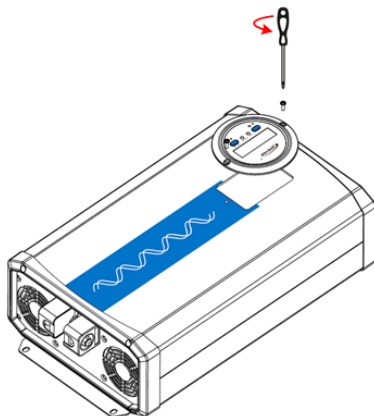

7. Protection

1) Input reverse polarity protection

The electronic circuit works to protect the inverter from damage during input reverse polarity. After correcting the connection, the inverter will work properly.

2) Input overvoltage protection

- Input overvoltage protection (“ U_i ” is DC input voltage)

| Models | Protection | Default | User-defined | Phenomenon |
|---------------|---------------------|---------|--------------|---|
| IP***-1*-Plus | $16V < U_i < 16.2V$ | 16V | 15.5~16.2V | The output is OFF after 5s Blue indicator fast flashing Buzzer sounds LCD display $\Delta I O V \downarrow$ |
| IP***-2*-Plus | $32V < U_i < 32.2V$ | 32V | 31~32.2V | |
| IP***-4*-Plus | $64V < U_i < 64.4V$ | 64V | 62~64.4V | |
| IP***-1*-Plus | $U_i \geq 16.2V^*$ | — | — | The output is OFF immediately Blue indicator fast flashing Buzzer sounds LCD display $\Delta I O V \downarrow$ |
| IP***-2*-Plus | $U_i \geq 32.2V^*$ | — | — | |
| IP***-4*-Plus | $U_i \geq 64.4V^*$ | — | — | |



★WARNING: The inverter has the input over voltage protection, but the surge voltage less than 20V for 12V system, 40V for 24V system, 80V for 48V system)

- Input overvoltage recover protection (“ U_i ” is DC input voltage)

| Models | Recover | Default | User-defined | Phenomenon |
|---------------|------------------|---------|--------------|---|
| IP***-1*-Plus | $U_i \leq 14.5V$ | 14.5V | 14~15V | The blue indicator on solid Output is ON |
| IP***-2*-Plus | $U_i \leq 29V$ | 29V | 28~30V | |
| IP***-4*-Plus | $U_i \leq 58V$ | 58V | 56~60V | |

3) Low voltage protection

- Low voltage protection (“ U_i ” is DC input voltage)

| Models | Protection | Default | User-defined | Phenomenon |
|---------------|-----------------------|---------|--------------|---|
| IP***-1*-Plus | $10.5V < U_i < 10.8V$ | 10.8V | 10.5~11.3V | The output is OFF after 5s The blue indicator slowly flashing Buzzer sounds |
| IP***-2*-Plus | $21V < U_i < 21.6V$ | 21.6V | 21~22.6V | |
| IP***-4*-Plus | $42V < U_i < 43.2V$ | 43.2V | 42~45.2V | |

| | | | | |
|----------------------|------------------|---|---|---|
| | | | | LCD display $\Delta IL \downarrow$ |
| IP***-1*-Plus | $U_i \leq 10.5V$ | — | — | The output is OFF immediately |
| IP***-2*-Plus | $U_i \leq 21.0V$ | — | — | The blue indicator slowly flashing |
| IP***-4*-Plus | $U_i \leq 42.0V$ | — | — | Buzzer sounds LCD display $\Delta IL \downarrow$ |

- Low voltage recover protection (“ U_i ” is DC input voltage)

| Models | Recover | Default | User-defined | Phenomenon |
|----------------------|------------------|---------|--------------|---|
| IP***-1*-Plus | $U_i \geq 12.5V$ | 12.5V | 12~13V | The blue indicator on solid Output is ON |
| IP***-2*-Plus | $U_i \geq 25V$ | 25V | 24~26V | |
| IP***-4*-Plus | $U_i \geq 50V$ | 50V | 48~52V | |

4) Overload protection

| | |
|---|--|
| $S = 1.2P_e$ ^① (S: Output power; P_e : Rated power) | The output is OFF after the 60s Red indicator slowly flashing Buzzer sounds LCD display ΔOOL |
| $S = 1.5P_e$ ^{①②} (S: Output power; P_e : Rated power) | The output is OFF after the 30s ^② Buzzer sounds Red indicator slowly flashing LCD display ΔOOL |
| $S = 1.8P_e$ ^① (S: Output power; P_e : Rated power) | The output is OFF after the 10s Buzzer sounds Red indicator slowly flashing LCD display ΔOOL |
| $S > 2P_e$ ^① (Input rated voltage) (S: Output power; P_e : Rated power) | The output is OFF after the 5s Buzzer sounds Red indicator slowly flashing LCD display ΔOOL |

NOTE:

① When the overload protection happens, the AC output will recover automatically for three times (the first time recover after 5s, 10s, 15s). After then the AC output will not recover automatically after 3 times attempt until restarting the inverter.

② IP3000-12-Plus does not have $S = 1.5P_e$ overload protection.

5) Load short circuit protection

| Phenomenon | Instruction |
|--|--|
| The output is OFF immediately Buzzer sounds | When the load short circuit protection happens, the AC output will automatically recover three times after 5s, 10s, 15s , |

| | |
|---|--|
| Red indicator fast flashing LCD display ΔOSC | recover automatically after 3 times attempt until restarting the inverter. |
|---|--|

6)Overtemperature Protection

| Phenomenon | Instruction |
|--|--|
| LCD display ΔOTP Inverter turns OFF | The heat sink or internal temperature is higher than some value. |
| Inverter turns ON | The heat sink or internal temperature is lower than some value. |

8. Troubleshooting



WARNING: DO NOT try to repair or maintain the inverter by own, and it may cause danger.

| Phenomenon | Possible reasons | Troubleshooting |
|---|--------------------------------|--|
| Blue indicator slowly flashing Buzzer sounds LCD display $\Delta IL \downarrow$ | DC input voltage under voltage | Measure the DC input voltage if the voltage is lower than 10.8/21.6/43.2V. Adjust the input voltage to recover normally. |
| Blue indicator fast flashing Buzzer sounds LCD display $\Delta IO \downarrow$ | DC input voltage overvoltage | Measure the DC input voltage if the voltage is lower than 16/32/64V. Adjust the input voltage to recover normally. |
| Red indicator slowly flashing Buzzer sounds LCD display ΔOL | Overload | <ul style="list-style-type: none"> Reduce the number of the AC load Restart the inverter |
| Red indicator fast flashing Buzzer sounds LCD display ΔOSC | Short circuit | <ul style="list-style-type: none"> Check carefully loads connection, clear the fault. Restart the inverter |
| Red and blue indicator on solid Buzzer sounds LCD display ΔOTP | Over-temperature | Improve ventilation quality, do NOT block the vent, reduce the temperature around the power supply, restart the device after the temperature drops, if still not working, please derate the power for use. |

9. Maintenance

The following inspections and maintenance tasks are recommended at least two times per year for the best performance.

- Make sure no block on airflow around the inverter. Clear up any dirt and fragments on the radiator.
- Check all the naked wires to make sure insulation does not damage for serious solarization—frictional wear, dryness, insects or rats, etc. Repair or replace some wires if necessary.
- Check and confirm that indicator and display is consistent with required. Pay attention to any troubleshooting or error indication. Take corrective action if necessary.
- Confirm that all the terminals have no corrosion, insulation damaged, high temperature or burnt/discolored sign, tighten terminal screws to the suggested torque.
- Check for dirt, nesting insects, and corrosion. If so, clear up in time.
- Check and confirm that the lightning arrester is in good condition. Replace a new one in time to avoid damaging the inverter/charger and even other equipment.



WARNING: Risk of electric shock!

Risk of electric shock! Before the above operations, make sure that all the power turns off, and the electricity in the capacitances is completely discharged, then follow the corresponding inspections and operations.

10. Technical Specifications

| Item | IP1500-12-Plus(T) |
|--|-----------------------------------|
| Output continuous power | 1500W @35°C @ Rated input voltage |
| Surge power | 3000W @5S |
| Output voltage | 220VAC(±3%);230VAC(-7%~+3%) |
| Output frequency | 50/60Hz±0.2% |
| Output wave | Pure Sine Wave |
| Output distortion THD | THD≤3%(Resistive load) |
| Load power factor | 0.2~1(VA≤Continuous output power) |
| Rated input voltage | 12VDC |
| Input voltage range | 10.8~16VDC |
| Rated output power efficiency ^① | >89% |
| Max. efficiency ^② | >93%(30% load) |
| Self-consumption | <0.2A |
| No-load current | <1.4A @12V |
| USB output | 5VDC/Max.1A |
| RS485 com. port | 5VDC/200mA |
| Environmental parameters | |
| Input terminal | M6 |
| Overall dimension (L*W*H) | 387×231.5×123mm |
| Mounting dimension | 361×145mm |
| Mounting hole size | φ6mm |
| Weight | 6kg |

①Load power is continuous output power when the DC input is the rated voltage (25°C)

②This efficiency is referred to the max. power when connected with different load under the rated DC input voltage.

| Item | IP2000-12-Plus(T) | IP2000-22-Plus(T) | IP2000-42-Plus(T) |
|--|-------------------------------------|--------------------|----------------------|
| Output continuous power | 2000W@35°C @ Rated input voltage | | |
| Surge power | 4000W@5S | | |
| Output voltage | 220VAC(±3%); 230VAC(-7%~+3%) | | |
| Output frequency | 50/60Hz±0.2% | | |
| Output wave | Pure Sine Wave | | |
| Output distortion THD | THD≤3%(Resistive load) | | |
| Load power factor | 0.2~1(VA ≤ Continuous output power) | | |
| Rated input voltage | 12VDC | 24VDC | 48VDC |
| Input voltage range | 10.8~ | 21.6~ | 43.2~ |
| | 16VDC | 32VDC | 64VDC |
| Rated output power efficiency ^① | >88% | >91% | >92.5% |
| Max. efficiency ^② | >94% (30% load) | >93% (30% load) | >94.5% (30% load) |
| Self-consumption | <0.2A | <0.2A | <0.2A |
| No-load current | <1.2A | <1.0A | <0.5A |
| USB output | 5VDC/Max.1A | | — |
| RS485 com. port | 5VDC/200mA | | |
| Environmental parameters | | | |
| Input terminal | M10 | M6 | M6 |
| Overall dimension (L*W*H) | 421×213.5×123mm | | |
| Mounting dimension | 395×145mm | | |
| Mounting hole size | φ6mm | | |
| Weight | 8kg | 6.5kg | 6.5kg |

①Load power is continuous output power when the DC input is the rated voltage (25°C)

②This efficiency is referred to the max. power when connected with different load under the rated DC input voltage.

| Item | IP3000-12-Plus(T) |
|--|-------------------------------------|
| Output continuous power | 3000W @35°C @ Rated input voltage |
| Surge power | 6000W @5S |
| Output voltage | 220VAC(±3%); 230VAC(-7%~+3%) |
| Output frequency | 50/60Hz±0.2% |
| Output wave | Pure Sine Wave |
| Output distortion THD | THD≤3%(Resistive load) |
| Load power factor | 0.2~1(VA ≤ Continuous output power) |
| Rated input voltage | 12VDC |
| Input voltage range | 10.8~16VDC |
| Rated output power efficiency ^① | > 87% |
| Max. efficiency ^② | > 94%(30% load) |
| Self-consumption | < 0.2A |
| No-load current | < 1.6A |
| USB output | 5VDC/Max.1A |
| RS485 com. port | 5VDC/200mA |
| Environmental parameters | |
| Input terminal | M10 |
| Overall dimension (L*W*H) | 557×231.5×123mm |
| Mounting dimension | 532×145mm |
| Mounting hole size | φ6mm |
| Weight | 10.5kg |

①Load power is continuous output power when the DC input is the rated voltage (25°C)

②This efficiency is referred to the max. power when connected with different load under the rated DC input voltage.

Environmental parameters

| | |
|---------------------|---|
| Working Temperature | -20°C ~ +50°C (Refer to the Reduced capacity curve) |
| Storage Temperature | -35°C ~ +70°C |
| Humidity | ≤95%(N.C.) |
| Enclosure | IP20 |
| Altitude | <5000m (Derating to operate according to IEC62040 at a height exceeding 1000m) |

Annex I Disclaimer

The warranty does not apply under the following conditions:

- Damage caused by improper use or use of an inappropriate environment.
- Battery voltage exceeds the input voltage limit of the inverter.
- Damage caused by the working environment temperature exceeds the rated range.
- Unauthorized dismantling the inverter or attempted repair to the inverter.
- Damage occurred during transportation or handling.
- Damage caused by force majeure.

Any changes without prior notice! Version number : V1.1

HUIZHOU EPEVER TECHNOLOGY CO., LTD.

Beijing Tel: +86-10-82894896/82894112

Huizhou Tel: +86-752-3889706

E-mail: info@epsolarpv.com

Website: www.epsolarpv.com

www.epever.com