



PURE SINE WAVE INVERTER

USER MANUAL



Models:
IP1500-Plus
IP2000-Plus
IP3000-Plus

Contents

Important Safety Instructions	1
1. Overview	6
2. Characteristics	8
3. Designations of models.....	10
4. Schematic diagram for connections.....	11
5. LCDdisplay unit.....	12
5.1 LCD	12
5.2 LED indicator and buzzer	12
5.3 Button.....	13
5.4 Display interface	13
5.5 Setting interface	13
5.6 Fault code	14
6. Installation instructions.....	15
6.1 General installation notes	15
6.2 Wire size & breaker.....	16
6.3 Mounting	16
6.4 Rotate the LCD	21
7. Protection	22
8. Troubleshooting.....	25
9. Maintenance.....	26
10. Technical Specifications	27
Annex I Disclaimer.....	31

Important Safety Instructions

Please reserve this manual for future review.

This manual contains all the instructions about safety, installation, and operation for the IPower Plus series pure sine wave inverter (Shown as “inverter” in the rest of the manual).

1. Symbols Definition

To ensure safety and use the product efficiently, when you see the below symbols in the manual, please pay attention to them and read the related content carefully.

TIP:

Indicates any practical advice for reference.



IMPORTANT:

Indicates a critical tip during the operation, if ignored, may cause the device to run in error.



CAUTION:

Indicates potential hazards, if not avoided, may cause the device damaged.



WARNING:

Indicates the danger of electric shock, if not avoided, would cause casualties.



WARNING HOT SURFACE:

Indicates the risk of high temperature, if not avoided, would cause scalds.



Read the manual carefully before any operation.



WARNING: The installation of the system must be done by professional technicians.

2. Requirements for technicians

- Professionally trained;

- Familiar with related safety specification of the electrical system;
- Read through the whole manual and be familiar with operating procedures and safety precautions.

3. Technicians operating permission

- Install the inverter to the specified location;
- Pretesting the inverter;
- Operation and maintenance of the inverter.

4. Safety cautions before installation



IMPORTANT: After receiving the inverter, please check the product condition first, if there is any damage occurred during shipping, please contact the transportation company or us in time.



CAUTION: Follow the instructions in the manual before placing or moving the inverter.



CAUTION: Make sure there isn't any electrical arcing danger around the operation area before installation.



CAUTION: Connect the inverter to the battery is highly recommended; the minimum capacity (Ah) of the battery should be 5 times of the inverter rated output power (P) divide by the battery voltage (V), which means $Ah=5 \times (P/V)$.



WARNING: Keep the inverter away from children.



WARNING: This off-grid inverter may be damaged if connected to the utility or electrical source.



WARNING: Only a single inverter is allowed to operate at a time. Do NOT connect multiple inverters in series or parallel. It may cause the inverter damaged.

5. Safety cautions for installation



WARNING: Make sure the inverter is clean and no electrical connection before installation.



WARNING: Make sure there is enough heat dissipation space for the inverter installation, and do not install the inverter in humid, greasy, flammable, explosive, dust accumulative or other severe environments.

6. Safety cautions for electrical connection



CAUTION: To avoid the danger of heat accumulation caused by the loose connection, please ensure all the cable connections are tight.



CAUTION: Please connect the inverter case to the ground and ensure the sectional area of the connection cable is not less than 4mm^2 .



CAUTION: Follow the parameter setting requirements to set the DC input voltage, higher or lower may cause the inverter down or even broken.



CAUTION: The cable between battery and inverter should be less than 3meters, otherwise, please reduce the current density.



CAUTION: A fuse or breaker is recommended between battery and inverter, also the rated current of the fuse or breaker should be two times of the inverter rated input current.



CAUTION: Keep the inverter away from the flooded lead-acid battery because the sparkle of the terminals may ignite the hydrogen released by the battery.



WARNING: Only the load is allowed to connect to the AC output terminal, do NOT connect it to power supply or utility, which may cause the inverter damaged, also please shut off the inverter before wiring.



WARNING: Do NOT directly connect the battery charger or similar devices to the input terminal of the inverter.

7. Safety cautions for inverter operation



WARNING HOT SURFACE: Do NOT touch the inverter when it's operating, the inverter case of the inverter will generate a high value of heat, also keep distance to the material or equipment affected by high temperature.



CAUTION: Do NOT open the inverter external case or try any operation when the inverter is ON.



WARNING: The AC output with high voltage during the inverter operation, do NOT touch any connection point, it may cause danger.

8. The dangerous operations which would cause electric arc, fire or explosion

- Touch the wire end, which hasn't been insulation treated, may cause electric shock.
- Touch the wiring copper row, terminals or internal devices, which may cause electric shock.
- The power cable connection is loose.
- Screw or other components inadvertently falls into the inverter.
- Incorrect operation by untrained non-professional people.



WARNING: When a fault occurs, please ask trained technicians to solve the issue. Any incorrect operation would cause a serious accident.

9. Safety cautions for shutting off the inverter

- The internal conductive devices are allowed to touch after the inverter has been shut off completely for ten minutes.
- The inverter is allowed to restart after removing the fault which affects the safety performance of the inverter.
- No maintenance parts are included in the inverter, please contact our customer service department for required maintenance service.



WARNING: Do NOT touch or open the external case before the device is shut off completely for ten minutes.

10. Safety cautions for inverter maintenance

- Testing equipment recommend to check the inverter without voltage or current;
- During installation and maintenance, please post temporary warning signs or put up roadblocks to prevent unrelated people from entering the area.
- Improper maintenance operations to the inverter may cause personal injury or equipment damage.
- To prevent electrostatic damage, please wear an antistatic wrist strap or avoid unnecessary contact with the circuit board.

1. Overview

IPower Plus is a new series of pure sine wave inverter which compatible with the lithium battery system. This new inverter with the input surge current suppression technology, which effectively prevents the damage of surge current to lithium battery cell and BMS (Battery Management System). Also, the smart voltage and current double closed-loop control algorithm bring the inverter a faster response and better resistance to load impact. The internal of the inverter uses high quality and high power density of the components to provide the stable, reliable, and sufficient power output for long time use. The optional communication solution allows people to monitor the operational status in real-time or change the parameters at any place.

The equipment fits multiple areas where need DC to AC, such as solar AC power system, vehicle system, RV power supply, security monitoring system, emergency lighting system, field power system, household power system, etc. The inverter with the EMC (Electro Magnetic Compatibility) characteristic is also available for higher power quality required place.

Feature:

- The input and output adopt completely isolated design
- Smart voltage and current double closed-loop control bring a faster response and better reliability.
- EMC characteristic which widely applied to higher quality requirement power system.
- Adoption of advanced SPWM technology and pure sine wave output
- Input surge current suppression technology to support the lithium battery system.
- Resistance to load impact supports impact loads (Air conditioner, Washing machine, Refrigerator, etc.)
- High power density and High-quality components to ensure reliability.
- Output power factor up to 1
- Low loss of no-load and standby.
- Low THD (Total Harmonic Distortion)

- High conversion efficiency.
- Extensive protection: input reverse polarity, input overvoltage, input low voltage, output overload, and short circuit, overheating.
- Air cooling control by dual condition (Temperature and Load)
- 180 degree rotatable LCD design to simplify the system wiring
- One-click control of operational status
- Friendly LCD design to simply monitor and parameter configure
- Supports phone Apps and PC software remote control
- Output voltage 220/230VAC and frequency 50/60Hz optional^①
- USB[®] ports to power DC fans, and other electronic equipments or charge phones.
- RS485 communication port supports multiple optional accessories.
- External switch contact design to allow remote control
- IEC62109, EN61000, RoHS approved

①Parameters can be monitored via inverter LCD, remote LCD, phone Apps, and PC software.

②USB function unavailable for 48V input inverters.

2. Characteristics

IP1500-12-Plus/IP2000-**-Plus

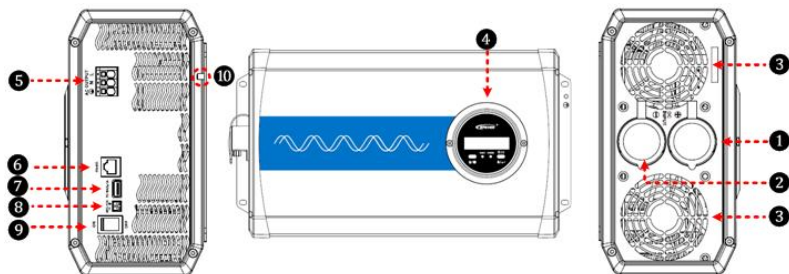

IP3000-12-Plus

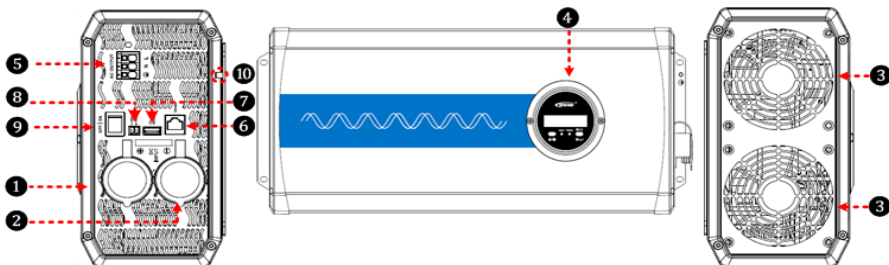

①	DC input terminal positive	⑥	RS485 communication port
②	DC input terminal negative	⑦	USB output port 5VDC/Max.1A [®]
③	Ventilation fan ^①	⑧	External switch connection point
④	LCD	⑨	Inverter switch
⑤	AC output terminal	⑩	Grounding terminal

① Ventilation fan

1) The cooling fan will automatically turn on if the inverter could reach any condition as below.

- Heat sink temperature is higher than 50°C.
- The Internal temperature is higher than 50°C.
- The output power is higher than 50% of the rated power.

2) The cooling fan will automatically turn off when the inverter reaches all the conditions as below.

- Heat sink temperature is lower than 40°C.
- The Internal temperature is lower than 40°C.
- The output power is lower than 40% of the rated power.

②The products of the 48V input system do not support the USB output port.

3. Designations of models

IP 3000 - 4 2 -Plus(T)

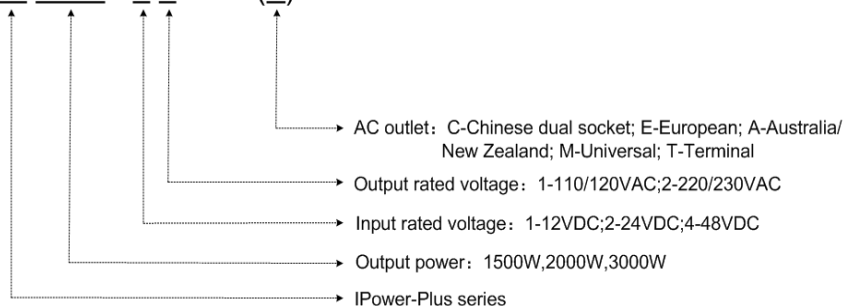

4. Schematic diagram for connections

IP1500-12-Plus/IP2000-**-Plus

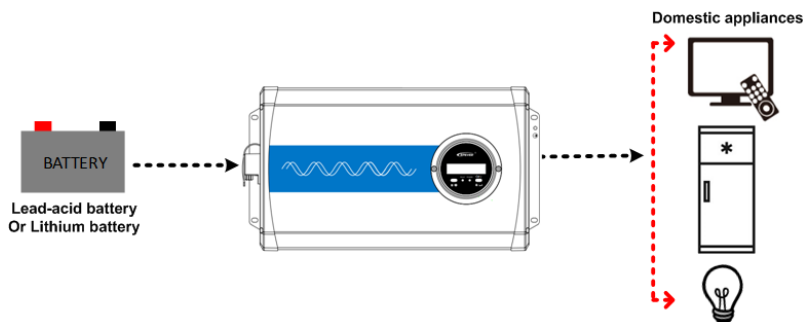

IP3000-12-Plus

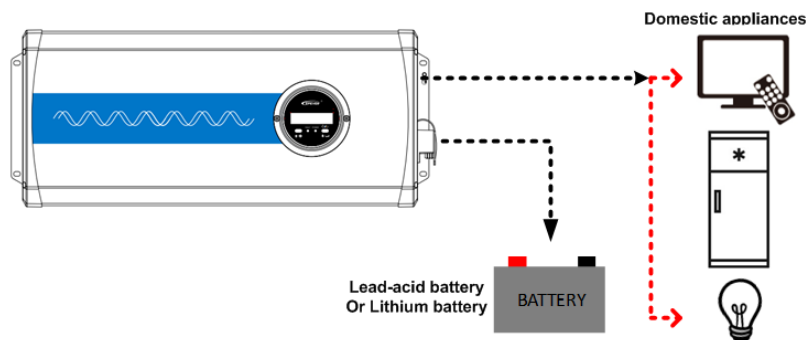

CAUTION: Suggest that the DC input terminal of the inverter directly connects to the battery. DO NOT connect to the battery terminal of the charge source. Otherwise, the charging voltage spikes of the charge source may lead to over-voltage protection of the inverter.

5. LCDdisplay unit

5.1LCD

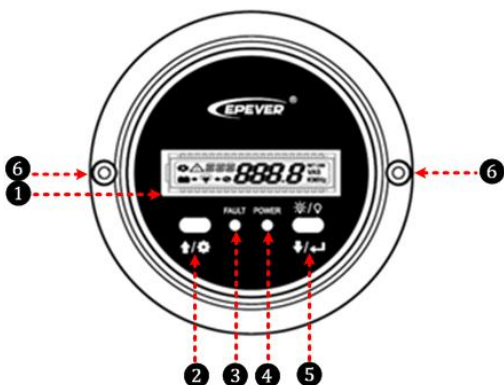

①	LCD	④	Working status indicator(Blue)
②	UP/Setting button	⑤	DOWN/Enter button Output ON/OFF button
③	Fault indicator(red)	⑥	Screw of the LCD

5.2 LED indicator and buzzer

Working status indicator	Fault indicator	Buzzer	Status
Blue on solid	Red off	Buzzer no sounds	Output is normal
Blue slowly flashing(1/4Hz)	Red off	Buzzer sounds	Input under voltage
Blue fast flashing(1Hz)	Red off	Buzzer sounds	Input overvoltage
Blue off	Red on solid	Buzzer sounds	Internal or heat sink over temperature
Blue off	Red fast flashing(1Hz)	Buzzer sounds	Load short circuit
Blue on solid	Red slowly	Buzzer	Load overload

	flashing(1/4Hz)	sounds	
Blue off	Red off	Buzzer sounds	The output voltage is abnormal

5.3 Button

	Press the button	Up
	Press the button and hold on 2s	Enter the setting interface at the real-time interface Enter the parameter's setting interface at the setting interface
	Press the button	Down
	Press the button and hold on 2s	The output is ON/OFF (Default ON) Enter the setting interface
	Press the button	Exit the parameter's setting interface at the setting interface
	Press the button and hold on 2s	Clear the faults at the real-time interface (Load short circuit or overload)



CAUTION: The long sound (300ms) of the buzzer is for setting parameters; the short sound (100ms) of the buzzer is for key operations.

5.4 Display interface

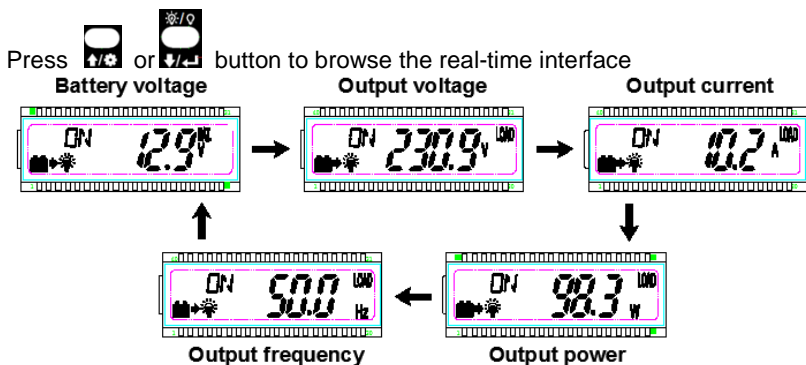

5.5 Setting interface

Operation

Step 1: Long press  to into the setting interface;

Step2: Press  or  to select the setting item;

Step3: Long press  and the digit is flashing to set the parameter;

Step4: Long press  to enter the parameter;

Step5: Press  and  to exit the setting interface.

Display	Parameter	Default	Setting range
⚙️ VPT	Output voltage class ^①	220Vac	220Vac/230Vac
		110Vac	110Vac/120Vac
⚙️ FRE	Output frequency class ^①	50Hz	50Hz/60Hz
⚙️ BLT	LCD backlight time	30s	30s/60s/100s(On Solid)
⚙️ LVD	Low voltage disconnect voltage ^②	10.8V	10.5V~11.3V; step size 0.1V
⚙️ LVR	Low voltage reconnect voltage ^②	12.5V	12.0V~13.0V; step size 0.1V
⚙️ OVR	Over voltage reconnect voltage ^②	14.5V	14.0V~15.0V; step size 0.1V
⚙️ OVD	Over voltage disconnect voltage ^②	16V	15.5V~16.2V; step size 0.1V

①The inverter must be restarted after change the parameters.

②4-6 parameters are in the 12V system at 25 °C; please double the values in the24V system and quadruple the values in the48V system.

③The user-defined range of 24V system is 31~32.2V, and the user-defined range of 24V system is for the 7 parameter.

5.6Fault code

Fault code	Fault	Buzzer
ΔTPT	Internal over temperature Heat sink over temperature	Sounds five times
ΔIOV	Input overvoltage	
ΔILV	Input low voltage	
ΔOSC	Output short circuit	
ΔOOL	Output overload	
ΔOVA	Output voltage is abnormal	

6. Installation instructions

6.1 General installation notes

- Please read the manual carefully to get familiar with the installation steps before installation.
- Be very careful when installing the batteries, especially flooded lead-acid batteries. Please wear eye protection, and have fresh water available to rinse if any contact with battery acid.
- Keep the battery away from any metal objects, which may cause a short circuit of the battery.
- Loose connections and corroded wires may result in high heat that can melt wire insulation, burn surrounding materials, or even cause a fire. Ensure tight connections and use cable clamps to secure cables and prevent them from swaying in motion.
- Please follow the parameter list to connect the DC input, even though the inverter has a high range of DC input voltages. Too high or too low may cause the inverter to stop working, even damage the inverter (Surge voltage less than 20V for 12V system, 40V for 24V system, 80V for 48V system)
- Select the system connection cables according to the current density no higher than $3.5A/mm^2$. (In accordance with the National Electrical Code Article 690, NFPA70).
- For outdoor installation, keep out of the direct sunshine and rain infiltration.
- High voltage still exists inside the inverter after turning off the switch, do not open or touch the internal devices, wait ten minutes before conducting related operations.
- Please do not install the inverter in humid, greasy, flammable, explosive, dust accumulative, or other severe environments.
- AC output is a high voltage, and please do not touch the wiring connection.
- When the fan is working, and please do not touch it to avoid injury.

6.2 Wire size & breaker

Wiring and installation should comply with national and local electrical requirements.

➤ Wire, terminals and breaker selection for battery

Models	Battery wire size	Ring Terminal	Breaker
IP1500-12-Plus(T)	35mm ² /1AWG	RNB38-6	DC—100A (2P in parallel)
IP2000-12-Plus(T)	50mm ² /1/0AWG	RNB60-10	DC—125A (2P in parallel)
IP2000-22-Plus(T)	25mm ² /3AWG	RNB22-6L	DC/2P—125A
IP2000-42-Plus(T)	16mm ² /6AWG	RNB22-6L	DC/2P—63A
IP3000-12-Plus(T)	70mm ² /3/0AWG	RNB60-10	DC—125A (3P in parallel)

➤ Wire and breaker selection for AC output

Models	Wire size	Breaker
IP1500-12-Plus(T)	1.5mm ² /15AWG	AC/2P—10A
IP2000-12-Plus(T)	2.5mm ² /13AWG	AC/2P—16A
IP2000-22-Plus(T)	2.5mm ² /13AWG	AC/2P—16A
IP2000-42-Plus(T)	2.5mm ² /13AWG	AC/2P—16A
IP3000-12-Plus(T)	4mm ² /11AWG	AC/2P—25A



IMPORTANT: The wire size and terminal are for reference only, use thicker wires to lower the voltage drop, and improve the system performance when the distance between inverter and batter is far.



IMPORTANT: The above wire size and circuit breaker size are for recommendation only, please choose suitable wire and circuit breaker according to the practical situation.

6.3 Mounting

Installation steps:

Step1: Professional personnel read this manual carefully.

Step2: Determination of installation location and heat-dissipation space.



IMPORTANT: The inverter shall be installed in a place with sufficient airflow through the dissipation pad of the inverter and a minimum clearance of 150mm from the upper and lower edges of the inverter to ensure natural thermal convection.



CAUTION: The inverter shall be cooling through case if installed in a closed box.

IP1500-12-Plus/IP2000-**-Plus

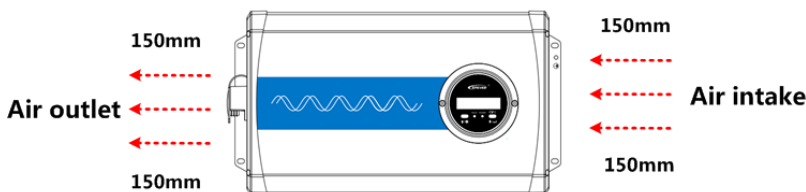

IP3000-12-Plus

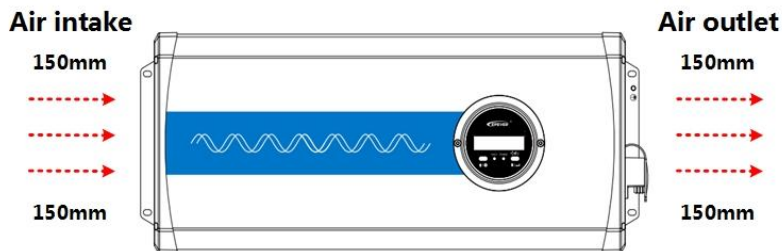

Step3: Wiring



WARNING: The AC equipment shall be determined by the continuous output power of the inverter, but the surge power must be lower than the instantaneous surge power of the inverter.



CAUTION: The switch of the inverter is OFF before wiring.



CAUTION: DO NOT close the circuit breaker or fuse and make sure that the leads of “+” and “-” poles are correctly connected while wiring the inverter.



CAUTION: A fuse which current is 2 to 2.5 times the rated current of the inverter, it must be installed on the battery side with a distance from the battery not greater than 150mm.

Wiring order:

1 Ground

IP1500-12/IP2000--Plus**

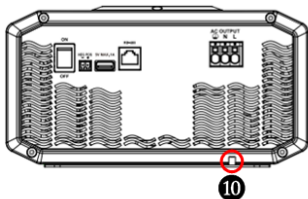

IP3000-12-Plus

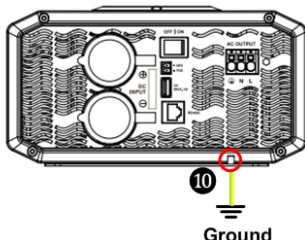

2 Battery

IP1500-12/IP2000--Plus**

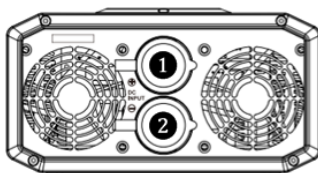

IP3000-12-Plus

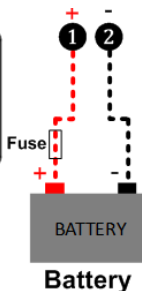
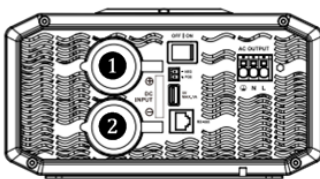

3 AC loads

1) AC output terminal definition

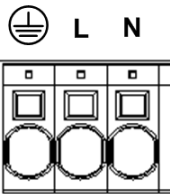
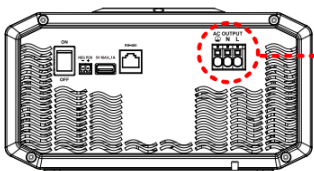

- ✦ Use multi-cores wire with no large than 4mm² is recommended
- ✦ Tin soldering to connection point when using multi-cores wires and directly insert into the related hole.
- ✦ Cut off the power and use a sharp tool to insert it into the small hole (on the top of the wire) before removing the wire.

2)Connect AC load

IP1500-12/IP2000--Plus**

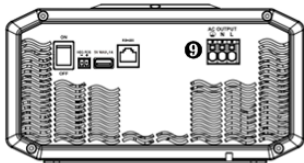

IP3000-12-Plus

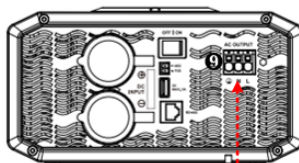

4 Accessories

1) **RS485 communication port**

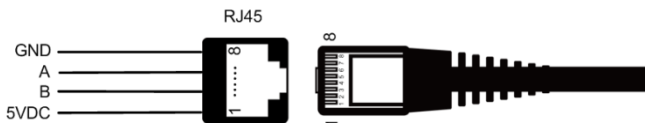

RJ45 pins definition:

Pins	Definition	Pins	Definition
1	5VDC	5	RS-485-A
2	5VDC	6	RS-485-A
3	RS-485-B	7	GND
4	RS-485-B	8	GND

2) Connect accessories

IP1500-12/IP2000-**-Plus



IP3000-12-Plus

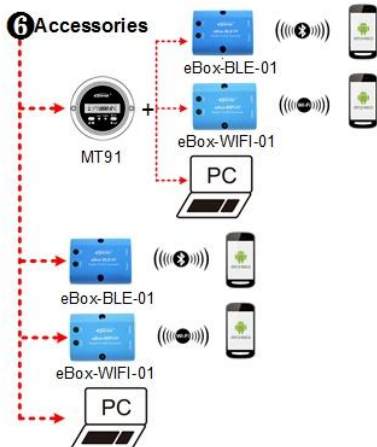
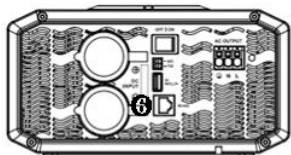

5 USB port

IP1500-12/IP2000-**-Plus

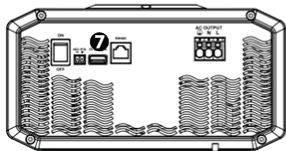

IP3000-12-Plus

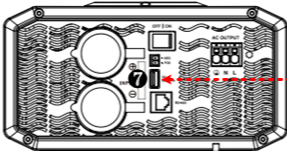

USB charge cable



Step4: Power on the inverter

- (1) Switch on the input breaker or the fuse between inverter and battery.
- (2) Turn on the power switch to start the inverter, blue indicator on solid, and the AC output is normal.
- (3) Turn on the load one by one, and check the operation status of both inverter and load.



CAUTION: If there are different types of loads, we suggests that

turn on the loads with higher startup current first, such as television, then at last the loads work stably, turn on the loads with lower startup current, such as an incandescent lamp.

- (4) If the fault indicator is red and the buzzer alarms when turn on the inverter, please switch off the loads and inverter immediately. Refer to **chapter 7 Troubleshooting**. After troubleshooting, please follow the above steps and operate again.

6.4 Rotate the LCD

- (1) Remove the screws with a screwdriver, then rotate the LCD 180°

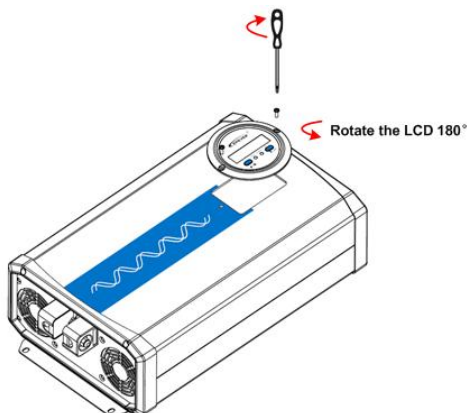

- (2) Set the screws of the LCD with a screwdriver.

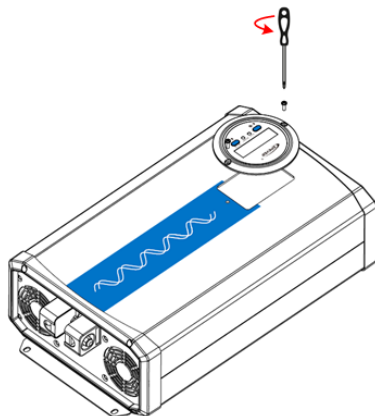

7. Protection

1) Input reverse polarity protection

The electronic circuit works to protect the inverter from damage during input reverse polarity. After correcting the connection, the inverter will work properly.

2) Input overvoltage protection

- Input overvoltage protection (“ U_i ” is DC input voltage)

Models	Protection	Default	User-defined	Phenomenon
IP***-1*-Plus	$16V < U_i < 16.2V$	16V	15.5~16.2V	The output is OFF after 5s Blue indicator fast flashing Buzzer sounds LCD display $\Delta I O V \downarrow$
IP***-2*-Plus	$32V < U_i < 32.2V$	32V	31~32.2V	
IP***-4*-Plus	$64V < U_i < 64.4V$	64V	62~64.4V	
IP***-1*-Plus	$U_i \geq 16.2V^*$	—	—	The output is OFF immediately Blue indicator fast flashing Buzzer sounds LCD display $\Delta I O V \downarrow$
IP***-2*-Plus	$U_i \geq 32.2V^*$	—	—	
IP***-4*-Plus	$U_i \geq 64.4V^*$	—	—	



★**WARNING:** The inverter has the input over voltage protection, but the surge voltage less than 20V for 12V system, 40V for 24V system, 80V for 48V system)

- Input overvoltage recover protection (“ U_i ” is DC input voltage)

Models	Recover	Default	User-defined	Phenomenon
IP***-1*-Plus	$U_i \leq 14.5V$	14.5V	14~15V	The blue indicator on solid Output is ON
IP***-2*-Plus	$U_i \leq 29V$	29V	28~30V	
IP***-4*-Plus	$U_i \leq 58V$	58V	56~60V	

3) Low voltage protection

- Low voltage protection (“ U_i ” is DC input voltage)

Models	Protection	Default	User-defined	Phenomenon
IP***-1*-Plus	$10.5V < U_i < 10.8V$	10.8V	10.5~11.3V	The output is OFF after 5s The blue indicator slowly flashing Buzzer sounds
IP***-2*-Plus	$21V < U_i < 21.6V$	21.6V	21~22.6V	
IP***-4*-Plus	$42V < U_i < 43.2V$	43.2V	42~45.2V	

				LCD display $\Delta IL \downarrow$
IP***-1*-Plus	$U_i \leq 10.5V$	—	—	The output is OFF immediately
IP***-2*-Plus	$U_i \leq 21.0V$	—	—	The blue indicator slowly flashing
IP***-4*-Plus	$U_i \leq 42.0V$	—	—	Buzzer sounds LCD display $\Delta IL \downarrow$

- Low voltage recover protection (“ U_i ” is DC input voltage)

Models	Recover	Default	User-defined	Phenomenon
IP***-1*-Plus	$U_i \geq 12.5V$	12.5V	12~13V	The blue indicator on solid Output is ON
IP***-2*-Plus	$U_i \geq 25V$	25V	24~26V	
IP***-4*-Plus	$U_i \geq 50V$	50V	48~52V	

4) Overload protection

$S = 1.2P_e$ ^① (S: Output power; P_e : Rated power)	The output is OFF after the 60s Red indicator slowly flashing Buzzer sounds LCD display ΔOOL
$S = 1.5P_e$ ^{①②} (S: Output power; P_e : Rated power)	The output is OFF after the 30s ^② Buzzer sounds Red indicator slowly flashing LCD display ΔOOL
$S = 1.8P_e$ ^① (S: Output power; P_e : Rated power)	The output is OFF after the 10s Buzzer sounds Red indicator slowly flashing LCD display ΔOOL
$S > 2P_e$ ^① (Input rated voltage) (S: Output power; P_e : Rated power)	The output is OFF after the 5s Buzzer sounds Red indicator slowly flashing LCD display ΔOOL

NOTE:

① When the overload protection happens, the AC output will recover automatically for three times (the first time recover after 5s, 10s, 15s). After then the AC output will not recover automatically after 3 times attempt until restarting the inverter.

② IP3000-12-Plus does not have $S = 1.5P_e$ overload protection.

5) Load short circuit protection

Phenomenon	Instruction
The output is OFF immediately Buzzer sounds	When the load short circuit protection happens, the AC output will automatically recover three times after 5s, 10s, 15s ,

Red indicator fast flashing LCD display ΔOSC	recover automatically after 3 times attempt until restarting the inverter.
---	--

6)Overtemperature Protection

Phenomenon	Instruction
LCD display ΔOTP Inverter turns OFF	The heat sink or internal temperature is higher than some value.
Inverter turns ON	The heat sink or internal temperature is lower than some value.

8. Troubleshooting



WARNING: DO NOT try to repair or maintain the inverter by own, and it may cause danger.

Phenomenon	Possible reasons	Troubleshooting
Blue indicator slowly flashing Buzzer sounds LCD display $\Delta IL \downarrow$	DC input voltage under voltage	Measure the DC input voltage if the voltage is lower than 10.8/21.6/43.2V. Adjust the input voltage to recover normally.
Blue indicator fast flashing Buzzer sounds LCD display $\Delta IO \downarrow$	DC input voltage overvoltage	Measure the DC input voltage if the voltage is lower than 16/32/64V. Adjust the input voltage to recover normally.
Red indicator slowly flashing Buzzer sounds LCD display ΔOL	Overload	<ul style="list-style-type: none"> • Reduce the number of the AC load • Restart the inverter
Red indicator fast flashing Buzzer sounds LCD display ΔOSC	Short circuit	<ul style="list-style-type: none"> • Check carefully loads connection, clear the fault. • Restart the inverter
Red and blue indicator on solid Buzzer sounds LCD display ΔOTP	Over-temperature	Improve ventilation quality, do NOT block the vent, reduce the temperature around the power supply, restart the device after the temperature drops, if still not working, please derate the power for use.

9. Maintenance

The following inspections and maintenance tasks are recommended at least two times per year for the best performance.

- Make sure no block on airflow around the inverter. Clear up any dirt and fragments on the radiator.
- Check all the naked wires to make sure insulation does not damage for serious solarization—frictional wear, dryness, insects or rats, etc. Repair or replace some wires if necessary.
- Check and confirm that indicator and display is consistent with required. Pay attention to any troubleshooting or error indication. Take corrective action if necessary.
- Confirm that all the terminals have no corrosion, insulation damaged, high temperature or burnt/discolored sign, tighten terminal screws to the suggested torque.
- Check for dirt, nesting insects, and corrosion. If so, clear up in time.
- Check and confirm that the lightning arrester is in good condition. Replace a new one in time to avoid damaging the inverter/charger and even other equipment.



WARNING: Risk of electric shock!

Risk of electric shock! Before the above operations, make sure that all the power turns off, and the electricity in the capacitances is completely discharged, then follow the corresponding inspections and operations.

10. Technical Specifications

Item	IP1500-12-Plus(T)
Output continuous power	1500W @35°C @ Rated input voltage
Surge power	3000W @5S
Output voltage	220VAC(±3%);230VAC(-7%~+3%)
Output frequency	50/60Hz±0.2%
Output wave	Pure Sine Wave
Output distortion THD	THD≤3%(Resistive load)
Load power factor	0.2~1(VA≤Continuous output power)
Rated input voltage	12VDC
Input voltage range	10.8~16VDC
Rated output power efficiency ^①	>89%
Max. efficiency ^②	>93%(30% load)
Self-consumption	<0.2A
No-load current	<1.4A@12V
USB output	5VDC/Max.1A
RS485 com. port	5VDC/200mA
Environmental parameters	
Input terminal	M6
Overall dimension (L*W*H)	387×231.5×123mm
Mounting dimension	361×145mm
Mounting hole size	φ6mm
Weight	6kg

①Load power is continuous output power when the DC input is the rated voltage (25°C)

②This efficiency is referred to the max. power when connected with different load under the rated DC input voltage.

Item	IP2000-12-Plus(T)	IP2000-22-Plus(T)	IP2000-42-Plus(T)
Output continuous power	2000W@35°C @ Rated input voltage		
Surge power	4000W@5S		
Output voltage	220VAC(±3%); 230VAC(-7%~+3%)		
Output frequency	50/60Hz±0.2%		
Output wave	Pure Sine Wave		
Output distortion THD	THD≤3%(Resistive load)		
Load power factor	0.2~1(VA ≤ Continuous output power)		
Rated input voltage	12VDC	24VDC	48VDC
Input voltage range	10.8~	21.6~	43.2~
	16VDC	32VDC	64VDC
Rated output power efficiency ^①	>88%	>91%	>92.5%
Max. efficiency ^②	>94% (30% load)	>93% (30% load)	>94.5% (30% load)
Self-consumption	<0.2A	<0.2A	<0.2A
No-load current	<1.2A	<1.0A	<0.5A
USB output	5VDC/Max.1A		—
RS485 com. port	5VDC/200mA		
Environmental parameters			
Input terminal	M10	M6	M6
Overall dimension (L*W*H)	421×213.5×123mm		
Mounting dimension	395×145mm		
Mounting hole size	φ6mm		
Weight	8kg	6.5kg	6.5kg

①Load power is continuous output power when the DC input is the rated voltage (25°C)

②This efficiency is referred to the max. power when connected with different load under the rated DC input voltage.

Item	IP3000-12-Plus(T)
Output continuous power	3000W @35°C @ Rated input voltage
Surge power	6000W @5S
Output voltage	220VAC(±3%); 230VAC(-7%~+3%)
Output frequency	50/60Hz±0.2%
Output wave	Pure Sine Wave
Output distortion THD	THD≤3%(Resistive load)
Load power factor	0.2~1(VA ≤ Continuous output power)
Rated input voltage	12VDC
Input voltage range	10.8~16VDC
Rated output power efficiency ^①	> 87%
Max. efficiency ^②	> 94%(30% load)
Self-consumption	< 0.2A
No-load current	< 1.6A
USB output	5VDC/Max.1A
RS485 com. port	5VDC/200mA
Environmental parameters	
Input terminal	M10
Overall dimension (L*W*H)	557×231.5×123mm
Mounting dimension	532×145mm
Mounting hole size	φ6mm
Weight	10.5kg

①Load power is continuous output power when the DC input is the rated voltage (25°C)

②This efficiency is referred to the max. power when connected with different load under the rated DC input voltage.

Environmental parameters

Working Temperature	-20°C ~ +50°C (Refer to the Reduced capacity curve)
Storage Temperature	-35°C ~ +70°C
Humidity	≤95%(N.C.)
Enclosure	IP20
Altitude	<5000m (Derating to operate according to IEC62040 at a height exceeding 1000m)

Annex I Disclaimer

The warranty does not apply under the following conditions:

- Damage caused by improper use or use of an inappropriate environment.
- Battery voltage exceeds the input voltage limit of the inverter.
- Damage caused by the working environment temperature exceeds the rated range.
- Unauthorized dismantling the inverter or attempted repair to the inverter.
- Damage occurred during transportation or handling.
- Damage caused by force majeure.

Any changes without prior notice! Version number : V1.1

HUIZHOU EPEVER TECHNOLOGY CO., LTD.

Beijing Tel: +86-10-82894896/82894112

Huizhou Tel: +86-752-3889706

E-mail: info@epsolarpv.com

Website: www.epsolarpv.com

www.epever.com