

## GENERAL FEATURES

- Environmentally friendly
- Wide operating temperature range
- Nano gel electrolyte and long Floating service Life
- Can be used at vertical or horizontal orientation
- High Power Density
- Low self discharge

## APPLICATIONS

- Telecom Control Equipments
- UPS systems
- Communication Equipments
- Medical Equipments
- Emergency Power Systems
- Security Systems
- Cable TV
- Railway System



## DIMENSIONS & WEIGHT

Length(mm)	520±1
Width(mm)	268±1
Height(mm)	220±1
Total Height(mm)	224±1
Weight(kg)	70.3±3%

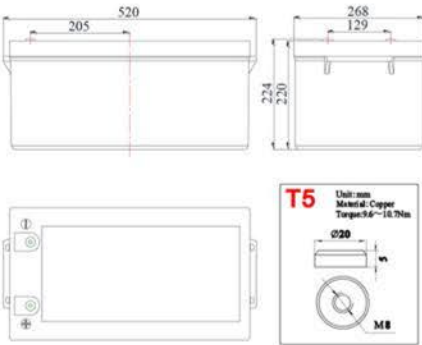

## COMPLIED STANDARDS

IEC 60896-21/22	JIS C8704
YD/T1360	BS6290 part4
GB/T 19638	UL 1989

## TECHNICAL SPECIFICATIONS



Nominal Voltage		12V(6 cells per unit)
Design Floating Life @25°C		12 Years
Nominal Capacity @25°C (10 hour rate@25.00A,10.80V)		250Ah
Capacity @25°C	20 hour rate (13.38A,10.5V)	267.6Ah
	5 hour rate (44.0A,10.5V)	220.0Ah
	1 hour rate (159.5A,9.6V)	159.5Ah
Internal Resistance	Full Charged Battery@25°C	≤2.8mΩ
Ambient Temperature	Discharge	-30°C~60°C
	Charge	-30°C~60°C
	Storage	-30°C~60°C
Max.Discharge Current@25°C		2000A(5s)
Capacity affected by Temperature (10 hr Capacity)	40°C	108%
	25°C	100%
	0°C	90%
	-15°C	70%
Self-Discharge@25°C per Month		3%
Charge (Constant Voltage) @25°C	Standby Use	Initial Charging Current Less than 50A Voltage 13.6-13.8V
	Cycle Use	Initial Charging Current Less than 50A Voltage 14.4-14.9V

## BATTERY DISCHARGE TABLE

### Discharge Constant Current per Cell (Amperes at 25°C)

F.V/Time	15min	30min	45min	1h	2h	3h	5h	6h	8h	10h	20h
1.60V	451.3	265.8	201.3	159.5	93.8	69.0	46.5	40.5	31.8	26.3	13.88
1.67V	426.3	251.8	193.5	154.8	90.8	66.8	45.8	39.8	31.5	25.8	13.75
1.70V	400.3	244.5	186.5	148.8	88.3	65.0	44.8	39.0	31.0	25.5	13.55
1.75V	375.0	233.8	178.3	142.8	86.0	63.5	44.0	38.3	30.5	25.3	13.38
1.80V	351.8	225.3	171.8	137.8	82.8	61.5	43.0	37.5	30.0	25.0	13.25

### Discharge Constant Power per Cell (Watts at 25°C)

F.V/Time	15min	30min	45min	1h	2h	3h	5h	6h	8h	10h	20h
1.60V	862.8	527.8	382.3	306.0	177.8	131.8	89.8	78.3	62.0	51.3	27.4
1.67V	825.5	494.8	369.3	297.8	173.0	128.3	88.3	77.0	61.5	50.8	27.2
1.70V	769.3	484.0	357.5	287.5	169.0	125.3	87.0	76.0	60.8	50.3	26.9
1.75V	721.8	460.8	343.3	277.0	165.0	122.8	85.8	74.8	60.0	49.8	26.6
1.80V	677.5	442.0	331.8	268.0	159.5	119.3	84.0	73.5	59.3	49.5	26.4

**Note** The above data are average values, and can be obtained within 3 charge/discharge cycles. These are not minimum values. Cell and battery designs/specifications are subject to modification without notice.

## PERFORMANCE CHARACTERISTICS

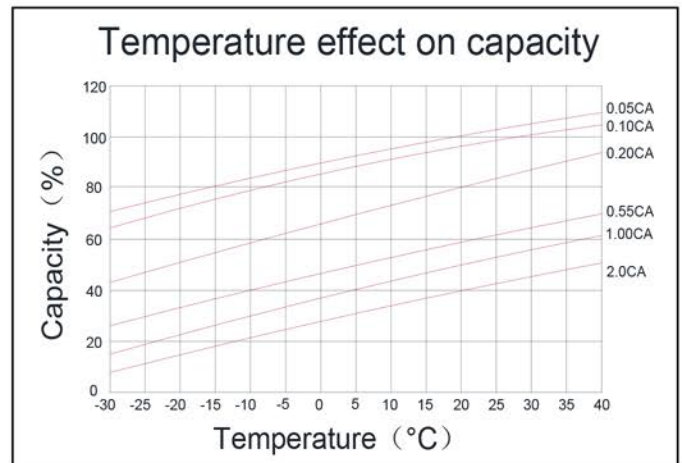
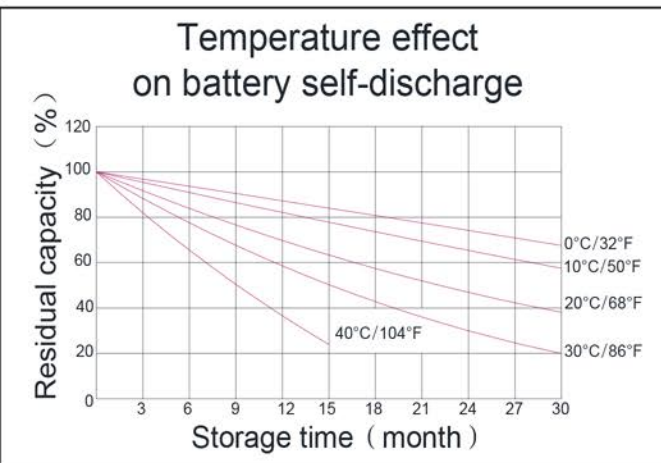
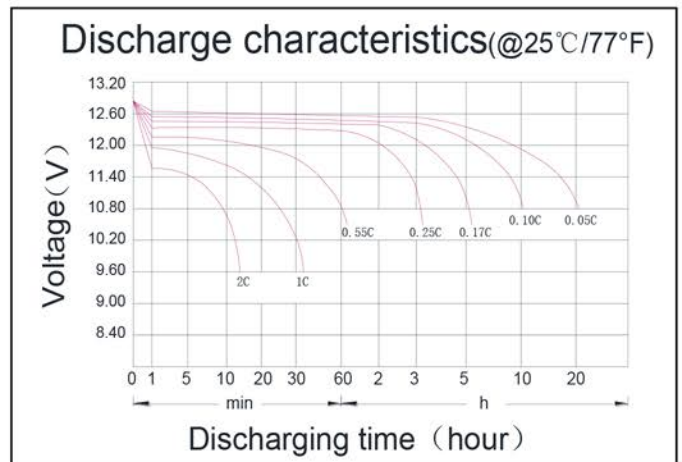
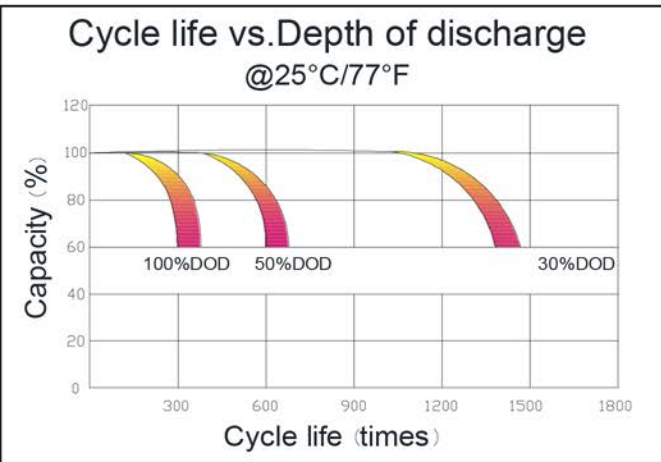
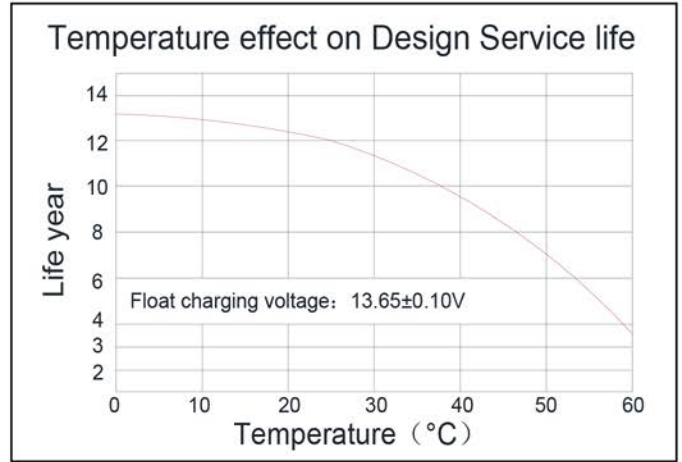
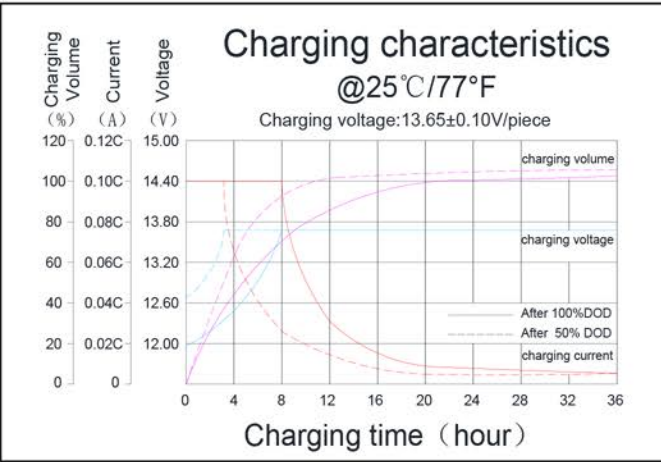

## BATTERY CONSTRUCTION

Component	Positive plate	Negative plate	Container & Cover	Safety valve	Terminal	Separator	Electrolyte	Pillar seal
Features	Thick high Sn low Ca grid with special paste	Balanced Pb-Ca grid for improved recombination efficiency	ABS (UL94-V0 optional)	Flame Si-Rubbeand aging resistancer	Female Copper Insert M8(torque:9 ~11N.m)	Advanced AGM separator for high pressure cell design	Dilute high purity sulphuric acid with fumed Silica gel	Two layers epoxy resin seal