

SH230C Specification

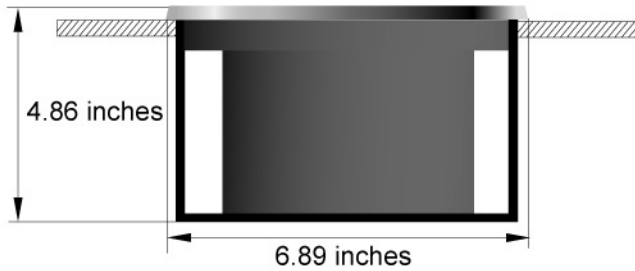
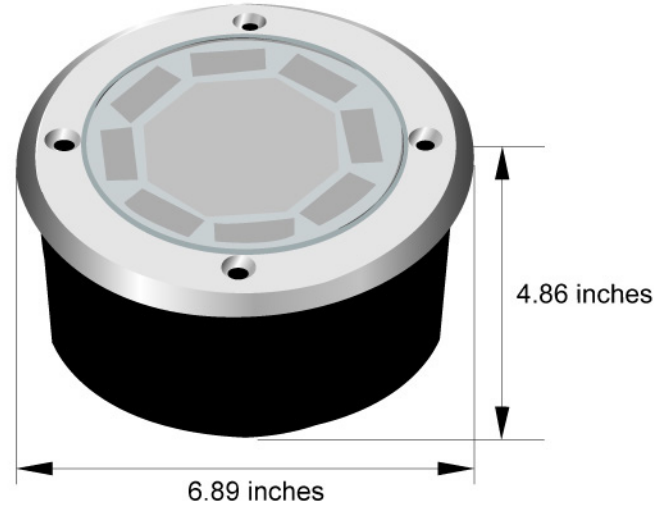

Solar-powered Brick

General

Size	Diameter : 6.89inches / 175mm Height : 4.86 inches / 124mm
Weight	3.76lbs / 1.71kgs
Housing	Stainless Steel(SUS304), cast aluminum
Lens	Anti-skid reinforce glass
Lighting output	Permanent
LED pcs	6 pcs

Operational

Switch	Auto
Operation time	Up to 12 hours(Sunny day) 4~6 hours(Cloudy day)
Full charge time	6 hours

Environmental

Compressive Strength	2818 lbs / 1281 kgs (minimum)
Operating Temperature	-4°F~140°F / -20°C~60°C
Storage Temperature	-13°F~176°F/-25°C~80°C
Moisture Protection	IP68

LEDs

LED life time*	100000 hours
LED intensity (mcd)*	3000~7000 mcd
LED luminance (Lux)*	30-300Lux
LED power consumption (W)*	1.8V-3.3V

*Remark : Specifications item depend on LED colors.

Solar Panel

Type	Crystalline panel 2V 180mA
Efficiency	12%~15%





Power storage

Type	Ultracapacitor 2.3V 360F
Life Time	10 years

Listing

Certification	CE, RoHs
---------------	----------

Color

 White	SH-230C-W
 Yellow	SH-230C-Y
 Red	SH-230C-R
 Blue	SH-230C-B
 Green	SH-230C-G